

Rexroth IndraDrive Drive Controllers Power Sections HCS02

R911339018
Edition 01

Operating Instructions



Title	Rexroth IndraDrive Drive Controllers Power Sections HCS02
Type of Documentation	Operating Instructions
Document Typecode	DOK-INDRV*-HCS02*****-IT01-EN-P
Internal File Reference	RS-ca4aa29c42c086270a6846a5003873e2-1-en-US-2
Purpose of Documentation	This documentation provides information on the installation and operation of the described products, by persons trained and qualified to work with electrical installations.
Copyright	© Bosch Rexroth AG 2013 This document, as well as the data, specifications and other information set forth in it, are the exclusive property of Bosch Rexroth AG. It may not be reproduced or given to third parties without its consent.
Liability	The specified data is intended for product description purposes only and shall not be deemed to be a guaranteed characteristic unless expressly stipulated in the contract. All rights are reserved with respect to the content of this documentation and the availability of the product.
Published by	Bosch Rexroth AG Bgm.-Dr.-Nebel-Str. 2 ■ 97816 Lohr a. Main, Germany Phone +49 9352 18 0 ■ Fax +49 9352 18 8400 http://www.boschrexroth.com/ DC-IA/EDY4 (CR)

<p style="text-align: center;">D Deutsch</p>	<p style="text-align: center;">USA English</p>	<p style="text-align: center;">F Français</p>
<p>▲WARNING Lebensgefahr bei Nichtbeachtung der nachstehenden Sicherheitshinweise!</p> <p>Nehmen Sie die Produkte erst dann in Betrieb, nachdem Sie die mit dem Produkt gelieferten Unterlagen und Sicherheitshinweise vollständig durchgelesen, verstanden und beachtet haben.</p> <p>Sollten Ihnen keine Unterlagen in Ihrer Landessprache vorliegen, wenden Sie sich an Ihren zuständigen Rexroth-Vertriebspartner.</p> <p>Nur qualifiziertes Personal darf an Antriebskomponenten arbeiten.</p> <p>Nähere Erläuterungen zu den Sicherheitshinweisen entnehmen Sie Kapitel 1 dieser Dokumentation.</p>	<p>▲WARNING Danger to life in case of non-compliance with the below-mentioned safety instructions!</p> <p>Do not attempt to install or put these products into operation until you have completely read, understood and observed the documents supplied with the product.</p> <p>If no documents in your language were supplied, please consult your Rexroth sales partner.</p> <p>Only qualified persons may work with drive components.</p> <p>For detailed explanations on the safety instructions, see chapter 1 of this documentation.</p>	<p>▲AVERTISSEMENT Danger de mort en cas de non-respect des consignes de sécurité figurant ci-après !</p> <p>Ne mettez les produits en service qu'après avoir lu complètement et après avoir compris et respecté les documents et les consignes de sécurité fournis avec le produit.</p> <p>Si vous ne disposez pas de la documentation dans votre langue, merci de consulter votre partenaire Rexroth.</p> <p>Seul un personnel qualifié est autorisé à travailler sur les composants d'entraînement.</p> <p>Vous trouverez des explications plus détaillées relatives aux consignes de sécurité au chapitre 1 de la présente documentation.</p>
<p>▲WARNING Hohe elektrische Spannung! Lebensgefahr durch elektrischen Schlag!</p> <p>Betreiben Sie Antriebskomponenten nur mit fest installiertem Schutzleiter.</p> <p>Schalten Sie vor Zugriff auf Antriebskomponenten die Spannungsversorgung aus.</p> <p>Beachten Sie die Entladezeiten von Kondensatoren.</p>	<p>▲WARNING High electrical voltage! Danger to life by electric shock!</p> <p>Only operate drive components with a permanently installed equipment grounding conductor.</p> <p>Disconnect the power supply before accessing drive components.</p> <p>Observe the discharge times of the capacitors.</p>	<p>▲AVERTISSEMENT Tensions électriques élevées ! Danger de mort par électrocution !</p> <p>N'exploitez les composants d'entraînement que si un conducteur de protection est installé de manière permanente.</p> <p>Avant d'intervenir sur les composants d'entraînement, coupez toujours la tension d'alimentation.</p> <p>Tenez compte des délais de décharge de condensateurs.</p>
<p>▲WARNING Gefahrbringende Bewegungen! Lebensgefahr!</p> <p>Halten Sie sich nicht im Bewegungsbereich von Maschinen und Maschinenteilen auf.</p> <p>Verhindern Sie den unbeabsichtigten Zutritt für Personen.</p> <p>Bringen Sie vor dem Zugriff oder Zutritt in den Gefahrenbereich die Antriebe sicher zum Stillstand.</p>	<p>▲WARNING Dangerous movements! Danger to life!</p> <p>Keep free and clear of the ranges of motion of machines and moving machine parts.</p> <p>Prevent personnel from accidentally entering the range of motion of machines.</p> <p>Make sure that the drives are brought to safe standstill before accessing or entering the danger zone.</p>	<p>▲AVERTISSEMENT Mouvements entraînant une situation dangereuse ! Danger de mort !</p> <p>Ne séjournez pas dans la zone de mouvement de machines et de composants de machines.</p> <p>Évitez tout accès accidentel de personnes.</p> <p>Avant toute intervention ou tout accès dans la zone de danger, assurez-vous de l'arrêt préalable de tous les entraînements.</p>
<p>▲WARNING Elektromagnetische / magnetische Felder! Gesundheitsgefahr für Personen mit Herzschrittmachern, metallischen Implantaten oder Hörgeräten!</p> <p>Zutritt zu Bereichen, in denen Antriebskomponenten montiert und betrieben werden, ist für oben genannten Personen untersagt bzw. nur nach Rücksprache mit einem Arzt erlaubt.</p>	<p>▲WARNING Electromagnetic / magnetic fields! Health hazard for persons with heart pacemakers, metal implants or hearing aids!</p> <p>The above-mentioned persons are not allowed to enter areas in which drive components are mounted and operated, or rather are only allowed to do this after they consulted a doctor.</p>	<p>▲AVERTISSEMENT Champs électromagnétiques / magnétiques ! Risque pour la santé des porteurs de stimulateurs cardiaques, d'implants métalliques et d'appareils auditifs !</p> <p>L'accès aux zones où sont montés et exploités les composants d'entraînement est interdit aux personnes susmentionnées ou bien ne leur est autorisé qu'après consultation d'un médecin.</p>
<p>▲VORSICHT Heiße Oberflächen (> 60 °C)! Verbrennungsgefahr!</p> <p>Vermeiden Sie das Berühren von metallischen Oberflächen (z. B. Kühlkörpern). Abkühlzeit der Antriebskomponenten einhalten (mind. 15 Minuten).</p>	<p>▲CAUTION Hot surfaces (> 60 °C [140 °F])! Risk of burns!</p> <p>Do not touch metallic surfaces (e.g. heat sinks). Comply with the time required for the drive components to cool down (at least 15 minutes).</p>	<p>▲ATTENTION Surfaces chaudes (> 60 °C)! Risque de brûlure !</p> <p>Évitez de toucher des surfaces métalliques (p. ex. dissipateurs thermiques). Respectez le délai de refroidissement des composants d'entraînement (au moins 15 minutes).</p>

D Deutsch	USA English	F Français
<p>⚠ VORSICHT Unsachgemäße Handhabung bei Transport und Montage! Verletzungsgefahr!</p> <p>Verwenden Sie geeignete Montage- und Transporteinrichtungen.</p> <p>Benutzen Sie geeignetes Werkzeug und persönliche Schutzausrüstung.</p>	<p>⚠ CAUTION Improper handling during transport and mounting! Risk of injury!</p> <p>Use suitable equipment for mounting and transport.</p> <p>Use suitable tools and personal protective equipment.</p>	<p>⚠ ATTENTION Manipulation incorrecte lors du transport et du montage ! Risque de blessure !</p> <p>Utilisez des dispositifs de montage et de transport adéquats.</p> <p>Utilisez des outils appropriés et votre équipement de protection personnel.</p>
<p>⚠ VORSICHT Unsachgemäße Handhabung von Batterien! Verletzungsgefahr!</p> <p>Versuchen Sie nicht, leere Batterien zu reaktivieren oder aufzuladen (Explosions- und Verätzungsgefahr).</p> <p>Zerlegen oder beschädigen Sie keine Batterien. Werfen Sie Batterien nicht ins Feuer.</p>	<p>⚠ CAUTION Improper handling of batteries! Risk of injury!</p> <p>Do not attempt to reactivate or recharge low batteries (risk of explosion and chemical burns).</p> <p>Do not dismantle or damage batteries. Do not throw batteries into open flames.</p>	<p>⚠ ATTENTION Manipulation incorrecte de piles! Risque de blessure!</p> <p>N'essayez pas de réactiver des piles vides ou de les charger (risque d'explosion et de brûlure par acide).</p> <p>Ne désassemblez et n'endommagez pas les piles. Ne jetez pas des piles dans le feu.</p>



E Español	P Português	I Italiano
<p>⚠ ADVERTENCIA ¡Peligro de muerte en caso de no observar las siguientes indicaciones de seguridad!</p> <p>Los productos no se pueden poner en servicio hasta después de haber leído por completo, comprendido y tenido en cuenta la documentación y las advertencias de seguridad que se incluyen en la entrega.</p> <p>Si no dispusiera de documentación en el idioma de su país, diríjase a su distribuidor competente de Rexroth.</p> <p>Solo el personal debidamente cualificado puede trabajar en componentes de accionamiento.</p> <p>Encontrará más detalles sobre las indicaciones de seguridad en el capítulo 1 de esta documentación.</p>	<p>⚠ ATENÇÃO Perigo de vida em caso de inobservância das seguintes instruções de segurança!</p> <p>Utilize apenas os produtos depois de ter lido, compreendido e tomado em consideração a documentação e as instruções de segurança fornecidas juntamente com o produto.</p> <p>Se não tiver disponível a documentação na sua língua, dirija-se ao seu parceiro de venda responsável da Rexroth.</p> <p>Apenas pessoal qualificado pode trabalhar nos componentes de acionamento.</p> <p>Explicações mais detalhadas relativamente às instruções de segurança constam no capítulo 1 desta documentação.</p>	<p>⚠ AVVERTENZA Pericolo di morte in caso di inosservanza delle seguenti indicazioni di sicurezza!</p> <p>Mettere in funzione i prodotti solo dopo aver letto, compreso e osservato per intero la documentazione e le indicazioni di sicurezza fornite con il prodotto.</p> <p>Se non dovesse essere presente la documentazione nella vostra lingua, siete pregati di rivolgervi al rivenditore Rexroth competente.</p> <p>Solo personale qualificato può eseguire lavori sui componenti di comando.</p> <p>Per ulteriori spiegazioni riguardanti le indicazioni di sicurezza consultare il capitolo 1 di questa documentazione.</p>
<p>⚠ ADVERTENCIA ¡Alta tensión eléctrica! ¡Peligro de muerte por descarga eléctrica!</p> <p>Active sólo los componentes de accionamiento con el conductor protector firmemente instalado.</p> <p>Desconecte la alimentación eléctrica antes de manipular los componentes de accionamiento.</p> <p>Tenga en cuenta los tiempos de descarga de los condensadores.</p>	<p>⚠ ATENÇÃO Alta tensão elétrica! Perigo de vida devido a choque elétrico!</p> <p>Opere componentes de acionamento apenas com condutores de proteção instalados.</p> <p>Desligue a alimentação de tensão antes de aceder aos componentes de acionamento.</p> <p>Respeite os períodos de descarga dos condensadores.</p>	<p>⚠ AVVERTENZA Alta tensione elettrica! Pericolo di morte in seguito a scosse elettriche!</p> <p>Mettere in esercizio i componenti di comando solo con conduttore di messa a terra ben installato.</p> <p>Staccare l'alimentazione prima di intervenire sui componenti di comando.</p> <p>Osservare i tempi di scarica del condensatore.</p>
<p>⚠ ADVERTENCIA ¡Movimientos peligrosos! ¡Peligro de muerte!</p> <p>No permanezca en la zona de movimiento de las máquinas ni de sus piezas.</p> <p>Impida el acceso accidental de personas.</p> <p>Antes de acceder o introducir las manos en la zona de peligro, los accionamientos se tienen que haber parado con seguridad.</p>	<p>⚠ ATENÇÃO Movimentos perigosos! Perigo de vida!</p> <p>Não permaneça na área de movimentação das máquinas e das peças das máquinas.</p> <p>Evite o acesso involuntário para pessoas.</p> <p>Antes de entrar ou aceder à área perigosa, imobilize os acionamentos de forma segura.</p>	<p>⚠ AVVERTENZA Movimenti pericolosi! Pericolo di morte!</p> <p>Non sostare nelle zone di manovra delle macchine e delle loro parti.</p> <p>Impedire un accesso non autorizzato per le persone.</p> <p>Prima di accedere alla zona di pericolo, arrestare e bloccare gli azionamenti.</p>



E Español	P Português	I Italiano
<p>⚠ ADVERTENCIA ¡Campos electromagnéticos/magnéticos! ¡Peligro para la salud de las personas con marcapasos, implantes metálicos o audífonos!</p> <p>El acceso de las personas arriba mencionadas a las zonas de montaje o funcionamiento de los componentes de accionamiento está prohibido, salvo que lo autorice previamente un médico.</p>	<p>⚠ ATENÇÃO Campos eletromagnéticos / magnéticos! Perigo de saúde para pessoas com marcapassos, implantes metálicos ou aparelhos auditivos!</p> <p>Acesso às áreas, nas quais os componentes de acionamento são montados e operados, é proibido para as pessoas em cima mencionadas ou apenas após permissão de um médico.</p>	<p>⚠ AVVERTENZA Campi elettromagnetici / magnetici! Pericolo per la salute delle persone portatrici di pacemaker, protesi metalliche o apparecchi acustici!</p> <p>L'accesso alle zone in cui sono installati o in funzione componenti di comando è vietato per le persone sopra citate o consentito solo dopo un colloquio con il medico.</p>
<p>⚠ ATENCIÓN ¡Superficies calientes (> 60 °C)! ¡Peligro de quemaduras!</p> <p>Evite el contacto con las superficies calientes (p. ej., disipadores de calor). Observe el tiempo de enfriamiento de los componentes de accionamiento (mín. 15 minutos).</p>	<p>⚠ CUIDADO Superfícies quentes (> 60 °C)! Perigo de queimaduras!</p> <p>Evite tocar superfícies metálicas (p. ex. radiadores). Respeite o tempo de arrefecimento dos componentes de acionamento (mín. 15 minutos).</p>	<p>⚠ ATTENZIONE Superfici bollenti (> 60 °C)! Pericolo di ustioni!</p> <p>Evitare il contatto con superfici metalliche (ad es. dissipatori di calore). Rispettare i tempi di raffreddamento dei componenti di comando (almeno 15 minuti).</p>
<p>⚠ ATENCIÓN ¡Manipulación inadecuada en el transporte y montaje! ¡Peligro de lesiones!</p> <p>Utilice dispositivos de montaje y de transporte adecuados.</p> <p>Utilice herramientas adecuadas y equipo de protección personal.</p>	<p>⚠ CUIDADO Manejo incorreto no transporte e montagem! Perigo de ferimentos!</p> <p>Utilize dispositivos de montagem e de transporte adequados.</p> <p>Utilize ferramentas e equipamento de proteção individual adequados.</p>	<p>⚠ ATTENZIONE Manipolazione inappropriata durante il trasporto e il montaggio! Pericolo di lesioni!</p> <p>Utilizzare dispositivi di montaggio e trasporto adatti.</p> <p>Utilizzare attrezzi adatti ed equipaggiamento di protezione personale.</p>
<p>⚠ ATENCIÓN ¡Manejo inadecuado de las pilas! ¡Peligro de lesiones!</p> <p>No trate de reactivar o cargar pilas descargadas (peligro de explosión y cauterización).</p> <p>No desarme ni dañe las pilas. No tire las pilas al fuego.</p>	<p>⚠ CUIDADO Manejo incorreto de baterias! Perigo de ferimentos!</p> <p>Não tente reativar nem carregar baterias vazias (perigo de explosão e de queimaduras com ácido).</p> <p>Não desmonte nem danifique as baterias. Não deite as baterias no fogo.</p>	<p>⚠ ATTENZIONE Utilizzo inappropriato delle batterie! Pericolo di lesioni!</p> <p>Non tentare di riattivare o ricaricare batterie scariche (pericolo di esplosione e corrosione).</p> <p>Non scomporre o danneggiare le batterie. Non gettare le batterie nel fuoco.</p>

S Svenska	DK Dansk	NL Nederlands
<p>⚠ VARNING Livsfara om följande säkerhetsanvisningar inte följs!</p> <p>Använd inte produkterna innan du har läst och förstått den dokumentation och de säkerhetsanvisningar som medföljer produkten, och följ alla anvisningar.</p> <p>Kontakta din Rexroth-återförsäljare om dokumentationen inte medföljer på ditt språk.</p> <p>Endast kvalificerad personal får arbeta med drivkomponenterna.</p> <p>Se kapitel 1 i denna dokumentation för närmare beskrivningar av säkerhetsanvisningarna.</p>	<p>⚠ ADVARSEL Livsfare ved manglende overholdelse af nedenstående sikkerhedsanvisninger!</p> <p>Tag ikke produktet i brug, før du har læst og forstået den dokumentation og de sikkerhedsanvisninger, som følger med produktet, og overhold de givne anvisninger.</p> <p>Kontakt din Rexroth-forhandler, hvis dokumentationen ikke medfølger på dit sprog.</p> <p>Det er kun kvalificeret personale, der må arbejde på drive components.</p> <p>Nærmere forklaringer til sikkerhedsanvisningerne fremgår af kapitel 1 i denne dokumentation.</p>	<p>⚠ WAARSCHUWING Levensgevaar bij niet-naleving van onderstaande veiligheidsinstructies!</p> <p>Stel de producten pas in bedrijf nadat u de met het product geleverde documenten en de veiligheidsinformatie volledig gelezen, begrepen en in acht genomen heeft.</p> <p>Mocht u niet beschikken over documenten in uw landstaal, kunt u contact opnemen met uw plaatselijke Rexroth distributiepartner.</p> <p>Uitsluitend gekwalificeerd personeel mag aan de aandrijvingscomponenten werken.</p> <p>Meer informatie over de veiligheidsinstructies vindt u in hoofdstuk 1 van deze documentatie.</p>
<p>⚠ VARNING Hög elektrisk spänning! Livsfara genom elchock!</p> <p>Använd endast drivkomponenterna med fastmonterad skyddsledare.</p> <p>Koppla bort spänningsförsörjningen före arbete på drivkomponenter.</p> <p>Var medveten om kondensatorernas urladdningstid.</p>	<p>⚠ ADVARSEL Elektrisk højspænding! Livsfare på grund af elektrisk stød!</p> <p>Drive components må kun benyttes med et fast installeret jordstik.</p> <p>Sørg for at koble spændingsforsyningen fra, inden du rører ved drive components.</p> <p>Overhold kondensatorernes afladningstider.</p>	<p>⚠ WAARSCHUWING Hoge elektrische spanning! Levensgevaar door elektrische schok!</p> <p>Bedien de aandrijvingscomponenten uitsluitend met vast geïnstalleerde aardleiding.</p> <p>Schakel voor toegang tot aandrijvingscomponenten de spanningsvoorziening uit.</p> <p>Neem de ontlaadtijden van condensatoren in acht.</p>

S Svenska	DK Dansk	NL Nederlands
<p>⚠️ VARNING Farliga rörelser! Livsfaral</p> <p>Uppehåll dig inte inom maskiners och maskindelarars rörelseområde.</p> <p>Förhindra att obehöriga personer får tillträde.</p> <p>Innan du börjar arbeta eller vistas inom drivsystemets riskområde måste maskinen vara stillastående.</p>	<p>⚠️ ADVARSEL Farlige bevægelser! Livsfare!</p> <p>Du må ikke opholde dig inden for maskiners og maskindeles bevægelsesradius.</p> <p>Sørg for, at ingen personer kan få utilsigtet adgang.</p> <p>Stands drevene helt, inden du rører ved drevene eller træder ind i deres fareområde.</p>	<p>⚠️ WAARSCHUWING Risicovolle bewegingen! Levensgevaar!</p> <p>Houdt u niet op in het bewegingsbereik van machines en machineonderdelen.</p> <p>Voorkom dat personen onbedoeld toegang verkrijgen.</p> <p>Voor toegang tot de gevaarlijke zone moeten de aandrijvingen veilig tot stilstand gebracht zijn.</p>
<p>⚠️ VARNING Elektromagnetiska/magnetiska fält! Hälsofara för personer med pacemaker, implantat av metall eller hörapparat!</p> <p>Det är förbjudet för ovan nämnda personer (eller kräver överläggning med läkare) att beträda områden där drivkomponenter är monterade och i drift.</p>	<p>⚠️ ADVARSEL Elektromagnetiske/magnetiske felter! Sundhedsfare for personer med pacemakere, metalliske implantater eller høreapparater!</p> <p>For disse personer er der adgang forbudt eller kun adgang med tilladelse fra læge til de områder, hvor drive components monteres og drives.</p>	<p>⚠️ WAARSCHUWING Elektromagnetische / magnetische velden! Gevaar voor de gezondheid van personen met pacemakers, metalen implantaten of hoorapparaten!</p> <p>Toegang tot gebieden, waarin aandrijvingscomponenten worden gemonteerd en bediend, is verboden voor voornoemde personen of uitsluitend toegestaan na overleg met een arts.</p>
<p>⚠️ OBSERVERA Varma ytor (> 60 °C)! Risk för brännskador!</p> <p>Undvik att vidröra metallytor (t.ex. kylelement). Var medveten om att det tar tid för drivkomponenterna att svalna (minst 15 minuter).</p>	<p>⚠️ FORSIGTIG Varme overflader (> 60 °C)! Risiko for forbrændinger!</p> <p>Undgå at berøre metaloverflader (f.eks. køleelementer). Overhold drive components nedkølingstid (min. 15 min.).</p>	<p>⚠️ VOORZICHTIG Hete oppervlakken (> 60 °C)! Verbrandingsgevaar!</p> <p>Voorkom contact met metalen oppervlakken (bijv. Koellichamen). Afkoeltijd van de aandrijvingscomponenten in acht nemen (min. 15 minuten).</p>
<p>⚠️ OBSERVERA Felaktig hantering vid transport och montering! Skaderisk!</p> <p>Använd passande monterings- och transportanordningar.</p> <p>Använd lämpliga verktyg och personlig skyddsutrustning.</p>	<p>⚠️ FORSIGTIG Fejlhåndtering ved transport og montering! Risiko for kvæstelser!</p> <p>Benyt egnede monterings- og transportanordninger.</p> <p>Benyt egnet værktøj og personligt sikkerhedsudstyr.</p>	<p>⚠️ VOORZICHTIG Onjuist gebruik bij transport en montage! Letselgevaar!</p> <p>Gebruik geschikte montage- en transportinrichtingen.</p> <p>Gebruik geschikt gereedschap en een persoonlijke veiligheidsuitrusting.</p>
<p>⚠️ OBSERVERA Felaktig hantering av batterier! Skaderisk!</p> <p>Försök inte återaktivera eller ladda upp batterier (risk för explosioner och frätskador).</p> <p>Batterierna får inte tas isär eller skadas. Släng inte batterierna i elden.</p>	<p>⚠️ FORSIGTIG Fejlhåndtering af batterier! Risiko for kvæstelser!</p> <p>Forsøg ikke at genaktivere eller oplade tomme batterier (eksplosions- og ætsningsfare).</p> <p>Undlad at skille batterier ad eller at beskadige dem. Smid ikke batterier ind i åben ild.</p>	<p>⚠️ VOORZICHTIG Onjuist gebruik van batterijen! Letselgevaar!</p> <p>Probeer nooit lege batterijen te reactiveren of op te laden (explosiegevaar en gevaar voor beschadiging van weefsel door cauterisatie).</p> <p>Batterijen niet demonteren of beschadigen. Nooit batterijen in het vuur werpen.</p>

 Suomi	 Polski	 Český
<p>VAROITUS Näiden turvaohjeiden noudattamatta jättämisestä on seurauksena hengenvaara!</p> <p>Ota tuote käyttöön vasta sen jälkeen, kun olet lukenut läpi tuotteen mukana toimitetut asiakirjat ja turvallisuusohjeet, ymmärtänyt ne ja ottanut ne huomioon.</p> <p>Jos asiakirjoja ei ole saatavana omalla äidinkielelläsi, ota yhteys asianomaiseen Rexrothin myyntiedustajaan.</p> <p>Käyttölaitteiden komponenttien parissa saa työskennellä ainoastaan valtuutettu henkilöstö.</p> <p>Lisätietoja turvaohjeista löydät tämän dokumentaation luvusta 1.</p>	<p>OSTRZEŻENIE Zagrożenie życia w razie nieprzestrzegania poniższych wskazówek bezpieczeństwa!</p> <p>Nie uruchamiać produktów przed uprzednim przeczytaniem i pełnym zrozumieniem wszystkich dokumentów dostarczonych wraz z produktem oraz wskazówek bezpieczeństwa. Należy przestrzegać wszystkich zawartych tam zaleceń.</p> <p>W przypadku braku dokumentów w Państwa języku, prosimy o skontaktowanie się z lokalnym partnerem handlowym Rexroth.</p> <p>Przy zespołach napędowych może pracować wyłącznie wykwalifikowany personel.</p> <p>Blizsze objaśnienia wskazówek bezpieczeństwa znajdują się w Rozdziale 1 niniejszej dokumentacji.</p>	<p>VAROVÁNÍ Nebezpečí života v případě nedodržení níže uvedených bezpečnostních pokynů!</p> <p>Před uvedením výrobků do provozu si přečtěte kompletní dokumentaci a bezpečnostní pokyny dodávané s výrobkem, pochopte je a dodržujte.</p> <p>Nemáte-li k dispozici podklady ve svém jazyce, obraťte se na příslušného obchodního partnera Rexroth.</p> <p>Na komponentách pohonu smí pracovat pouze kvalifikovaný personál.</p> <p>Podrobnější vysvětlení k bezpečnostním pokynům naleznete v kapitole 1 této dokumentace.</p>
<p>VAROITUS Voimakas sähköjännite! Sähköiskun aiheuttama hengenvaara!</p> <p>Käytä käyttölaitteen komponentteja ainoastaan maadoitusjohtimen ollessa kiinteästi asennettuna.</p> <p>Katkaise jännitteensyöttö ennen käyttölaitteen komponenteille suoritettavien töiden aloittamista.</p> <p>Huomioi kondensaattoreiden purkausajat.</p>	<p>OSTRZEŻENIE Wysokie napięcie elektryczne! Zagrożenie życia w wyniku porażenia prądem!</p> <p>Zespoły napędu mogą być eksploatowane wyłącznie z zainstalowanym na stałe przewodem ochronnym.</p> <p>Przed uzyskaniem dostępu do podzespołów napędu należy odłączyć zasilanie elektryczne.</p> <p>Zwracać uwagę na czas rozładowania kondensatorów.</p>	<p>VAROVÁNÍ Vysoké elektrické napětí! Nebezpečí života při zasažení elektrickým proudem!</p> <p>Komponenty pohonu smí být v provozu pouze s pevně nainstalovaným ochranným vodičem.</p> <p>Než začnete zasahovat do komponent pohonu, odpojte je od elektrického napájení.</p> <p>Dodržujte vybíjecí časy kondenzátorů.</p>
<p>VAROITUS Vaarallisia liikkeitä! Hengenvaara!</p> <p>Älä oleskele koneiden tai koneenosien liikealueella.</p> <p>Pidä huolta siitä, ettei muita henkilöitä pääse alueelle vahingossa.</p> <p>Pysäytä käyttölaitteet varmasti ennen vaara-alueelle koskemista tai menemistä.</p>	<p>OSTRZEŻENIE Niebezpieczne ruchy! Zagrożenie życia!</p> <p>Nie wolno przebywać w obszarze pracy maszyny i jej elementów.</p> <p>Nie dopuszczać osób niepowołanych do obszaru pracy maszyny.</p> <p>Przed dotknięciem urządzenia/maszyny lub zbliżeniem się do obszaru zagrożenia należy zgodnie z zasadami bezpieczeństwa wyłączyć napędy.</p>	<p>VAROVÁNÍ Nebezpečné pohyby! Nebezpečí života!</p> <p>Nezdržujte se v dosahu pohybu strojů a jejich součástí.</p> <p>Zabraňte náhodnému přístupu osob.</p> <p>Před zásahem nebo vstupem do nebezpečného prostoru bezpečně zastavte pohonu.</p>
<p>VAROITUS Sähkömagneettisia/magneettisia kenttiä! Terveystieteellisten haittojen vaara henkilöille, joilla on sydämentahdistin, metallinen implantti tai kuulolaite!</p> <p>Yllä mainituilta henkilöiltä on pääsy kielletty alueelle, joilla asennetaan tai käytetään käyttölaitteen komponentteja, tai heidän on ensin saatava tähän suostumus lääkäriltään.</p>	<p>OSTRZEŻENIE Pola elektromagnetyczne / magnetyczne! Zagrożenie zdrowia dla osób z rozrusznikiem serca, metalowymi implantami lub aparatami słuchowymi!</p> <p>Wstęp na teren, gdzie odbywa się montaż i eksploatacja napędów jest dla ww. osób zabroniony względnie dozwolony po konsultacji z lekarzem.</p>	<p>VAROVÁNÍ Elektromagnetická/magnetická pole! Nebezpečí pro zdraví osob s kardiostimulátory, kovovými implantáty nebo naslouchadly!</p> <p>Výše uvedené osoby mají zakázán přístup do prostorů, kde jsou montovány a používány komponenty pohonu, resp. ho mají povolen pouze po poradě s lékařem.</p>
<p>HUOMIO Kuumia pintoja (> 60 °C)! Palovammojen vaara!</p> <p>Vältä metallipintojen koskettamista (esim. jäähdytyslevyt). Noudata käyttölaitteen komponenttien jäähtymisaikoja (väh. 15 minuuttia).</p>	<p>PRZESTROGA Gorące powierzchnie (> 60 °C)! Niebezpieczeństwo poparzenia!</p> <p>Unikać kontaktu z powierzchniami metalowymi (np. radiatorami). Przestrzegać czasów schładzania podzespołów napędów (min. 15 minut).</p>	<p>UPOZORNĚNÍ Horké povrchy (> 60 °C)! Nebezpečí popálení!</p> <p>Nedotýkejte se kovových povrchů (např. chladičích těles). Dodržujte dobu ochlazení komponent pohonu (min. 15 minut).</p>

 Suomi	 Polski	 Český
<p>▲ HUOMIO Epäasianmukainen käsittely kuljetuksen ja asennuksen yhteydessä! Loukkaantumisaara!</p> <p>Käytä soveltuvia asennus- ja kuljetuslaitteita.</p> <p>Käytä omia työkaluja ja henkilökohtaisia suojavarusteita.</p>	<p>▲ PRZESTROGA Niewłaściwe obchodzenie się podczas transportu i montażu! Ryzyko urazu!</p> <p>Stosować odpowiednie urządzenia montażowe i transportowe.</p> <p>Stosować odpowiednie narzędzia i środki ochrony osobistej.</p>	<p>▲ UPOZORNĚNÍ Nesprávné zacházení při přepravě a montáži! Nebezpečí zranění!</p> <p>Používejte vhodná montážní a dopravní zařízení.</p> <p>Používejte vhodné nářadí a osobní ochranné vybavení.</p>
<p>▲ HUOMIO Paristonjen epäasianmukainen käsittely! Loukkaantumisaara!</p> <p>Älä yritä saada tyhjiä paristoja toimimaan tai ladata niitä uudelleen (räjähdys- ja syöpymisaara).</p> <p>Älä hajota paristoja osiin tai vaurioita niitä. Älä heitä paristoja tullen.</p>	<p>▲ PRZESTROGA Niewłaściwe obchodzenie się z bateriami! Ryzyko urazu!</p> <p>Nie próbować reaktywować i nie ładować zużytych baterii (niebezpieczeństwo wybuchu oraz poparzenia żrącą substancją).</p> <p>Nie demontować i nie niszczyć baterii. Nie wrzucać baterii do ognia.</p>	<p>▲ UPOZORNĚNÍ Nesprávné zacházení s bateriemi! Nebezpečí zranění!</p> <p>Nepokoušejte se znovu aktivovat nebo dobíjet prázdné baterie (nebezpečí výbuchu a poleptání).</p> <p>Nerozebírejte ani nepoškožujte baterie. Neházejte baterie do ohně.</p>

 Slovensko	 Slovenčina	 Română
<p>▲ OPOZORILO Življenjska nevarnost pri neupoštevanju naslednjih napotkov za varnost!</p> <p>Izdelke začnite uporabljati šele, ko v celoti preberete, razumete in upošteвате izdelkom priloženo dokumentacijo in varnostne napotke.</p> <p>Če priložena dokumentacija ni na voljo v vašem maternem jeziku, se obrnite na pristojnega distributerja Rexroth.</p> <p>Samo kvalificirano osebje sme delati na pogonskih komponentah.</p> <p>Podrobnejša pojasnila o varnostnih navodilih najdete v poglavju 1 v tej dokumentaciji.</p>	<p>▲ VAROVANIE Nebezpečnostvo ohrotenia života pri nedodržiavaní nasledujúcich bezpečnostných pokynov!</p> <p>Výrobky uvádzajte do prevádzky až potom, čo ste úplne prečítali, pochopili a zobrali do úvahy podklady a bezpečnostné pokyny dodané s výrobkom.</p> <p>Ak by ste nemali k dispozícii žiadne podklady v jazyku svojej krajiny, obráťte sa prosím na svojho príslušného predajcu Rexroth.</p> <p>Na komponentoch pohonu smie pracovať iba kvalifikovaný personál.</p> <p>Bližšie vysvetlenia k bezpečnostným pokynom zistíte z kapitoly 1 tejto dokumentácie.</p>	<p>▲ AVERTIZARE Pericol de moarte în cazul nerespectării următoarelor instrucțiuni de siguranță!</p> <p>Punerea în funcțiune a produselor trebuie efectuată după citirea, înțelegerea și respectarea documentelor și instrucțiunilor de siguranță, care sunt livrate împreună cu produsele.</p> <p>În cazul în care documentele nu sunt în limba dumneavoastră maternă, vă rugăm să contactați partenerul de vânzări Rexroth.</p> <p>Numai un personal calificat poate lucra cu componentele de acționare.</p> <p>Explicații detaliate privind instrucțiunile de siguranță găsiți în capitolul 1 al acestei documentații.</p>
<p>▲ OPOZORILO Visoka električna napetost! Življenjska nevarnost zaradi električnega udara!</p> <p>Pogonske komponente uporabljajte samo s fiksno nameščenim zaščitnim vodnikom.</p> <p>Pred dostopom do pogonske komponente odklopite napajanje.</p> <p>Upošteвайте čase praznjenja kondenzatorjev.</p>	<p>▲ VAROVANIE Vysoké elektrické napätie! Nebezpečnostvo ohrotenia života v dôsledku zásahu elektrickým prúdom!</p> <p>Komponenty pohonu prevádzkujte iba s pevne nainštalovaným ochranným vodičom.</p> <p>Pred prístupom na komponenty pohonu odpojte zdroj napätia.</p> <p>Rešpektujte časy vybitia kondenzátorov.</p>	<p>▲ AVERTIZARE Tensiune electrică înaltă! Pericol de moarte prin electrocutare!</p> <p>Exploatați componentele de acționare numai cu împământarea instalată permanent.</p> <p>Înainte de intervenția asupra componentelor de acționare, deconectați alimentarea cu tensiune electrică.</p> <p>Țineți cont de timpii de descărcare ai condensatorilor.</p>
<p>▲ OPOZORILO Nevarni premiki! Življenjska nevarnost!</p> <p>Ne zadržujte se v območju delovanja strojev.</p> <p>Preprečite nenadzorovan dostop oseb.</p> <p>Pred prijemom ali dostopom v nevarno območje varno zaustavite vse gnane dele.</p>	<p>▲ VAROVANIE Pohyby prinášajúce nebezpečnostvo! Nebezpečnostvo ohrotenia života!</p> <p>Nezdržiaвайте sa v oblasti pohybu strojov a častí strojov.</p> <p>Zabráňte nepovolanému prístupu osôb.</p> <p>Pred zásahom alebo prístupom do nebezpečnej oblasti uveďte pohony bezpečne do zastavenia.</p>	<p>▲ AVERTIZARE Mișcări periculoase! Pericol de moarte!</p> <p>Nu staționați în zona de mișcare a mașinilor și a componentelor în mișcare a mașinilor.</p> <p>Împiedicați accesul neintenționat al persoanelor în zona de lucru a mașinilor.</p> <p>Înainte de intervenția sau accesul în zona periculoasă, opriți în siguranță componentele de acționare.</p>

SLO Slovensko	SK Slovenčina	RO Română
<p>⚠ OPOZORILO Elektromagnetna / magnetna polja! Nevarnost za zdravje za osebe s spodbujevalniki srca, kovinskimi vsadki ali slušnimi aparati!</p> <p>Dostop do območij, v katerih so nameščene delujoče pogonske komponente, je za zgoraj navedene osebe prepovedan oz. dovoljen samo po posvetu z zdravnikom.</p>	<p>⚠ VAROVANIE Elektromagnetické/ magnetické polia! Nebezpečenstvo pre zdravie osôb s kardioštimulátormi, kovovými implantátmi alebo načúvacími prístrojmi!</p> <p>Prístup k oblastiam, v ktorých sú namontované a prevádzkujú sa komponenty pohonu, je pre hore uvedené osoby zakázaný resp. je dovolený iba po konzultácii s lekárom.</p>	<p>⚠ AVERTIZARE Câmpuri electromagnetice / magnetice! Pericol pentru sănătatea persoanelor cu stimuloare cardiace, implanturi metalice sau aparate auditive!</p> <p>Intrarea în zone, în care se montează sau se exploatează componente de acționare, este interzisă pentru persoanele sus numite respectiv este permisă numai cu acordul medicului.</p>
<p>⚠ POZOR Vroče površine (> 60 °C)! Nevarnost opeklin!</p> <p>Izogibajte se stiku s kovinskimi površinami (npr. hladilnimi telesii). Upoštevajte čas hlajenja pogonskih komponent (najm. 15 minut).</p>	<p>⚠ UPOZORNENIE Horúce povrchy (> 60 °C)! Nebezpečenstvo popálenia!</p> <p>Zabráňte kontaktu s kovovými povrchmi (napr. chladiacimi telesami). Dodržiavajte čas vychladenia komponentov pohonu (min. 15 minút).</p>	<p>⚠ ATENȚIE Suprafețe fierbinți (> 60 °C)! Pericol de arsuri!</p> <p>Nu atingeți suprafețele metalice (de ex. radiatoare de răcire). Respectați timpii de răcire ai componentelor de acționare (min. 15 minute).</p>
<p>⚠ POZOR Nestrokovno ravnanje med transportom in nameštivijo! Nevarnost poškodb!</p> <p>Uporablajte ustrezne pripomočke za nameščanje in transport.</p> <p>Uporabite ustrezno orodje in osebno zaščitno opremo.</p>	<p>⚠ UPOZORNENIE Neodborná manipulácia pri transporte a montáži! Nebezpečenstvo poranenia!</p> <p>Používajte vhodné montážne a transportné zariadenia.</p> <p>Používajte vhodné náradie a osobné ochranné prostriedky.</p>	<p>⚠ ATENȚIE Manipulare necorespunzătoare la transport și montaj! Pericol de vătămare!</p> <p>Utilizați dispozitive adecvate de montaj și transport.</p> <p>Folosiți instrumente corespunzătoare și echipament personal de protecție.</p>
<p>⚠ POZOR Nepravilno ravnanje z baterijami! Nevarnost poškodb!</p> <p>Ne poskušajte ponovno aktivirati ali napolniti praznih baterij (Nevarnost zaradi eksplozije ali jedkanja).</p> <p>Ne razstavljajte ali poškodujte nobenih baterij. Baterij ne mečite v ogenj.</p>	<p>⚠ UPOZORNENIE Neodborná manipulácia s batériami! Nebezpečenstvo poranenia!</p> <p>Nepokúšajte sa reaktivovať alebo nabíjať prázdne batérie (nebezpečenstvo výbuchu a poleptania).</p> <p>Batérie nerozoberajte ani nepoškodzuje. Nehádzte batérie do ohňa.</p>	<p>⚠ ATENȚIE Manipulare necorespunzătoare a bateriilor! Pericol de vătămare!</p> <p>Nu încercați să reactivați sau să încărcăți bateriile goale (pericol de explozie și pericol de arsuri).</p> <p>Nu dezasmblați și nu deteriorați bateriile. Nu aruncați bateriile în foc.</p>

H Magyar	BG Български	LV Latviski
<p>⚠ FIGYELMEZTETÉS! Az alábbi biztonsági útmutatások figyelmen kívül hagyása életveszélyes helyzethez vezethet!</p> <p>Üzembe helyezés előtt olvassa el, értelmezze, és vegye figyelembe a csomagban található dokumentumban foglaltakat és a biztonsági útmutatásokat.</p> <p>Amennyiben a csomagban nem talál az Ön nyelvén írt dokumentumokat, vegye fel a kapcsolatot az illetékes Rexroth-képviselővel.</p> <p>A hajtás alkatrészein kizárólag képzett személy dolgozhat.</p> <p>A biztonsági útmutatókkal kapcsolatban további magyarázatot ennek a dokumentumnak az első fejezetében találhat.</p>	<p>⚠ ПРЕДУПРЕЖДЕНИЕ Опасност за живота при неспазване на посочените подолу инструкции за безопасност!</p> <p>Използвайте продуктите след като сте се запознали подробно с приложената към продукта документация и указания за безопасност, разбрали сте ги и сте се съобразили с тях.</p> <p>Ако текстът не е написан на Вашия език, моля обърнете се към Вашия компетентен търговски представител на Rexroth.</p> <p>Със задвижващите компоненти трябва да работи само квалифициран персонал.</p> <p>Подробни пояснения към инструкциите за безопасност можете да видите в Глава 1 на тази документация.</p>	<p>⚠ BRĪDINĀJUMS Turpinājuma drošības norādījumu neievērošana var apdraudēt dzīvību!</p> <p>Sāciet lietot izstrādājumu tikai pēc tam, kad esat pilnībā izlasījuši, sapratuši un nēmuši vērā kopā ar izstrādājumu piegādātos dokumentus.</p> <p>Ja dokumenti nav pieejami Jūsu valsts valodā, vērsieties pie pilnvarotā Rexroth izplatītāja.</p> <p>Darbus pie piedziņas komponentiem drīkst veikt tikai kvalificēts personāls.</p> <p>Detalizētus paskaidrojumus attiecībā uz drošības norādījumiem skatiet šī dokumenta 1. nodaļā.</p>
<p>⚠ FIGYELMEZTETÉS! Magas elektromos feszültség! Életveszély áramütés miatt!</p> <p>A hajtás alkatrészeit csak véglegesen telepített védővezetővel üzemeltesse!</p> <p>Mielőtt hozzányúl a hajtás alkatrészeihez, kapcsolja ki az áramellátást.</p> <p>Ügyeljen a kondenzátorok kisülési idejére!</p>	<p>⚠ ПРЕДУПРЕЖДЕНИЕ Високо електрическо напрежение! Опасност за живота от удар от електрически ток!</p> <p>Работете със задвижващите компоненти само при здраво закрепен заземяващ проводник.</p> <p>Преди работа по задвижващите компоненти, изключете захранващото напрежение.</p> <p>Обърнете внимание на времето за разреждане на кондензаторите.</p>	<p>⚠ BRĪDINĀJUMS Augsts elektriskais spriegums! Dzīvības apdraudējums elektriskā trieciena dēļ!</p> <p>Piedziņas komponentus darbiniet tikai ar fiksēti uzstādītu zemējumvadu.</p> <p>Pirms darba pie piedziņas komponentiem atslēdziet elektroapgādi.</p> <p>Nemiet vērā kondensatoru izlādes laikus.</p>

H Magyar	BG Български	LV Latviski
<p>▲ FIGYELMEZTETÉS! Veszélyes mozgás! Életveszély!</p> <p>Ne tartózkodjon a gépek és a gépkatrészek mozgási területén belül!</p> <p>Illetéktelen személyeket ne engedjen a gép közelébe!</p> <p>Mielőtt beavatkozik, vagy a veszélyes zónába lép a hajtásokat biztonságosan állítsa le.</p>	<p>▲ ПРЕДУПРЕЖДЕНИЕ Опасни движения! Опасност за живота!</p> <p>Не стойте в обсега на движение на машините и частите на машините.</p> <p>Не допускайте непреднамерен достъп на хора.</p> <p>Преди работа или влизане в опасната зона, спрете надеждно приводния механизъм.</p>	<p>▲ BRĪDINĀJUMS Bīstamas kustības! Dzīvības apdraudējums!</p> <p>Neuzturieties mašīnu un mašīnas detaļu kustību zonā.</p> <p>Novērsiet nepiederošu personu piekļūšanu.</p> <p>Pirms darba bīstamajās zonās pilnībā apstādiniet piedziņu.</p>
<p>▲ FIGYELMEZTETÉS! Elektromágneses / mágneses mező! Káros hatással lehet a szívritmus-szabályozó készülékkel, fémbelüktetéssel vagy hallókészülékkel rendelkezők egészségére!</p> <p>Azokra a területekre, ahol hajtások alkatrészeit szerelik és üzemeltetik, a fent említett személyeknek tilos a belépés, illetve csak orvosi konzultációt követően szabad az adott területekre lépniük.</p>	<p>▲ ПРЕДУПРЕЖДЕНИЕ Електромагнитни / магнитни полета! Опасност за здравето на хора със сърдечни стимулатори, метални импланти или слухови апарати!</p> <p>Достъпът за гореспоменатите лица до зони, в които ще се монтират и ще работят задвижващи компоненти се забранява, или разрешава само след консултация с лекар.</p>	<p>▲ BRĪDINĀJUMS Elektromagnētiskais / magnētiskais lauks! Veselības apdraudējums personām ar sirds stimulatoriem, metāliskiem implantiem vai dzirdes aparātiem!</p> <p>Tuvošanās zonām, kurās tiek montēti un darbināti piedziņas komponenti, iepriekš minētajām personām ir aizliegta, respektīvi, atļauta tikai pēc konsultēšanās ar ārstu.</p>
<p>▲ VIGYÁZAT! Forró felületek (> 60 °C)! Égésveszély!</p> <p>Ne érjen hozzá fémfelületekhez (pl. hűtőtetekhez)! Vegye figyelembe a hajtás alkatrészeinek kihűlési idejét (min. 15 perc)!</p>	<p>▲ ВНИМАНИЕ Горещи повърхности (> 60 °C)! Опасност от изгаряне!</p> <p>Не докосвайте метални повърхности (например радиатори). Съблюдавайте времето на охлаждане на задвижващите компоненти (мин. 15 минути).</p>	<p>▲ UZMANĪBU Karstas virsmas (> 60 °C)! Apdedzināšanās risks!</p> <p>Neskarīties pie metāliskām virsmām (piemēram, dzesētāja). Ļaujiet piedziņas komponentiem atdzist (min. 15 minūtes).</p>
<p>▲ VIGYÁZAT! Szakszerűtlen kezelés szállításkor és szereléskor! Sérülésveszély!</p> <p>A megfelelő beszerelési és szállítási eljárásokat alkalmazza!</p> <p>Használjon megfelelő szerszámokat és személyes védőfelszerelést!</p>	<p>▲ ВНИМАНИЕ Неправилно боравене по време на транспорт и монтаж! Опасност от нараняване!</p> <p>Използвайте подходящо монтажно и транспортно оборудване.</p> <p>Използвайте подходящи инструменти и лични предпазни средства.</p>	<p>▲ UZMANĪBU Nepareizi veikta transportēšana un montāža! Traumu gūšanas risks!</p> <p>Izmantojiet piemērotas montāžas un transportēšanas ierīces.</p> <p>Izmantojiet piemērotus instrumentus un individuālos aizsardzības līdzekļus.</p>
<p>▲ VIGYÁZAT! Akkumulátorok szakszerűtlen kezelése! Sérülésveszély!</p> <p>Üres akkumulátorokat ne aktiváljon újra, illetve ne töltsön fel (robbanás- és marásveszély)!</p> <p>Az akkumulátorokat ne szedje szét, és ne rongálja meg! Az akkumulátort ne dobja tűzbe!</p>	<p>▲ ВНИМАНИЕ Неправилно боравене с батерии! Опасност от нараняване!</p> <p>Не се опитвайте да активирате отново или да зареждате разредени батерии (Опасност от експлозия и напръскване с агресивен агент).</p> <p>Не разглобявайте и не повреждайте батерии. Не хвърляйте батерии в огън.</p>	<p>▲ UZMANĪBU Nepareiza bateriju lietošana! Traumu gūšanas risks!</p> <p>Nemēģiniet no jauna aktivizēt vai uzlādēt tukšas baterijas (eksploziju un ķīmisko apdegumu draudi).</p> <p>Neizjauciet un nesabojājat baterijas. Nemetiet baterijas ugunī.</p>

<p style="text-align: center;">LT Lietuviškai</p>	<p style="text-align: center;">EST Eesti</p>	<p style="text-align: center;">GR Ελληνικά</p>
<p>⚠️ ISPĖJIMAS Pavojus gyvybei nesilaikant toliau pateikiamų saugumo nurodymų!</p> <p>Naudokite gaminį tik kruopščiai perskaitę prie jo pridėtus aprašus, saugumo nurodymus. Susipažinkite su jais ir vadovaukitės naudodami gaminį.</p> <p>Jeį Jūs negavote aprašo gimtąja kalba, kreipkitės į igaliotus Rexroth atstovus.</p> <p>Prie pavaros komponentų leidžiama dirbti tik kvalifikuotam personalui.</p> <p>Išsamesnius saugumo nurodymų paaiškinimus rasite šios dokumentacijos 1 skyriuje.</p>	<p>⚠️ HOIATUS Alljärgnevatate ohutusjuhiste eiramine on eluohtlik!</p> <p>Võtke tooted käiku alles siis, kui olete toodetega kaasasolevad materjalid ning ohutusjuhised täielikult läbi lugenud, neist aru saanud ja neid järginud.</p> <p>Kui Teil puuduvad emakeelsed materjalid, siis pöörduge Rexrothi kohaliku müügiesinduse poole.</p> <p>Ajamikomponentidega tohib töötada üksnes kvalifitseeritud personal.</p> <p>Täpsemaid selgitusi ohutusjuhiste kohta leiate käesoleva dokumentatsiooni peatükist 1.</p>	<p>⚠️ ΠΡΟΕΙΔΟΠΟΙΗΣΗ Κίνδυνος θανάτου σε περίπτωση μη συμμόρφωσης με τις παρακάτω οδηγίες ασφαλείας!</p> <p>Θέστε το προϊόν σε λειτουργία αφού διαβάσετε, κατανοήσετε και λάβετε υπόψη το σύνολο των οδηγιών ασφαλείας που το συνοδεύουν.</p> <p>Εάν δεν υπάρχει τεκμηρίωση στη γλώσσα σας, απευθυνθείτε σε εξουσιοδοτημένο αντιπρόσωπο της Rexroth.</p> <p>Μόνο εξειδικευμένο προσωπικό επιτρέπεται να χειρίζεται στοιχεία μετάδοσης κίνησης.</p> <p>Περαιτέρω επεξηγήσεις των οδηγιών ασφαλείας διατίθενται στο κεφάλαιο 1 της παρούσας τεκμηρίωσης.</p>
<p>⚠️ ISPĖJIMAS Aukšta elektros įtampa! Pavojus gyvybei dėl elektros smūgio!</p> <p>Pavaros komponentus eksploatuokite tik su fiksuotai instaliuotu apsauginiu laidu.</p> <p>Prieš prieidami prie pavaros komponentų išjunkite maitinimo įtampą.</p> <p>Atsižvelkite į kondensatorių išsikrovimo trukmę.</p>	<p>⚠️ HOIATUS Kõrge elektripinge! Eluohtlik elektrilõõgi tõttu!</p> <p>Käitage ajamikomponente üksnes püsival installaeritud maandusega.</p> <p>Lülitage enne ajamikomponentidega tööde alustamist toitepinge välja.</p> <p>Järgige kondensaatorite mahalaadumisaegu.</p>	<p>⚠️ ΠΡΟΕΙΔΟΠΟΙΗΣΗ Υψηλή ηλεκτρική τάση! Κίνδυνος θανάτου από ηλεκτροπληξία!</p> <p>Θέτετε σε λειτουργία τα στοιχεία μετάδοσης κίνησης μόνο εφόσον έχει τοποθετηθεί καλά προστατευτικός αγωγός γείωσης.</p> <p>Πριν από οποιαδήποτε παρέμβαση, αποσυνδέστε την τροφοδοσία των στοιχείων μετάδοσης κίνησης.</p> <p>Λάβετε υπόψη τους χρόνους αποφόρτισης των πυκνωτών.</p>
<p>⚠️ ISPĖJIMAS Pavojingi judesiai! Pavojus gyvybei!</p> <p>Nebūkite mašinų ar jų dalių judėjimo zonoje. Neleiskite netyčia patekti asmenims.</p> <p>Prieš patekdam į pavojaus zoną saugiai išjunkite pavaras.</p>	<p>⚠️ HOIATUS Ohtlikud liikumised! Eluohtlik!</p> <p>Ärge viibige masina ja masinaosade liikumispiirkonnas.</p> <p>Tõkestage inimeste ettekavatsematu sisenemine masina ja masinaosade liikumispiirkonda.</p> <p>Tagage ajamite turvaline seiskamine enne ohupiirkonda juurdepääsu või sisenemist.</p>	<p>⚠️ ΠΡΟΕΙΔΟΠΟΙΗΣΗ Επικίνδυνες τάσεις! Κίνδυνος θανάτου!</p> <p>Μην στέκεστε στην περιοχή κίνησης μηχανημάτων και εξαρτημάτων.</p> <p>Αποτρέψτε την τυχαία είσοδο ατόμων.</p> <p>Πριν από την παρέμβαση ή πρόσβαση στην περιοχή κινδύνου, μεριμνήστε για την ασφαλή ακινητοποίηση των συστημάτων μετάδοσης κίνησης.</p>
<p>⚠️ ISPĖJIMAS Elektromagnetiniai / magnetiniai laukai! Pavojus asmenų su širdies stimulatoriais, metaliniais implantaais arba klausos aparatais sveikatai!</p> <p>Prieiga prie zonų, kuriose montuojami ir eksploatuojami pavaros komponentai, aukščiau nurodytiems asmenims yra draudžiama arba leistina tik pasitarus su gydytoju.</p>	<p>⚠️ HOIATUS Elektromagnetilised / magnetilised väljad! Terviseohtlik südamestimulaatorite, metallimplantaatide ja kuulmisseadmetega inimestele!</p> <p>Sisenemine piirkondadesse, kus toimub ajamikomponentide monteerimine ja käitamine, on ülalnimetatud isikutele keelatud või lubatud üksnes pärast arstiga konsulteerimist.</p>	<p>⚠️ ΠΡΟΕΙΔΟΠΟΙΗΣΗ Ηλεκτρομαγνητικά/ μαγνητικά πεδία! Κίνδυνος για την υγεία ατόμων με καρδιακούς βηματοδότες, μεταλλικά εμφυτεύματα ή συσκευές ακοής!</p> <p>Η είσοδος σε περιοχές όπου πραγματοποιείται συναρμολόγηση και λειτουργία στοιχείων μετάδοσης κίνησης απαγορεύεται στα προαναφερθέντα άτομα, εκτός αν τους έχει δοθεί σχετική άδεια κατόπι συνεννόησης με γιατρό.</p>
<p>⚠️ PERSPĖJIMAS Karšti paviršiai (> 60 °C)! Nudėgimo pavojus!</p> <p>Venkite liesti metalinius paviršius (pvz., radiatorių). Išlaikykite pavaros komponentų atvėsimą trukmę (bent 15 minučių).</p>	<p>⚠️ ETTEVAATUST Kuumad välispinnad (> 60 °C)! Põletusoh!</p> <p>Vältige metalsete välispindade (nt radiaatorid) puudutamist. Pidage kinni ajamikomponentide mahajahtumisajast (vähemalt 15 minutit).</p>	<p>⚠️ ΠΡΟΣΟΧΗ Καυτές επιφάνειες (> 60 °C)! Κίνδυνος εγκαύματος!</p> <p>Αποφεύγετε την επαφή με μεταλλικές επιφάνειες (π.χ. μονάδες ψύξης). Λάβετε υπόψη το χρόνο ψύξης των στοιχείων μετάδοσης κίνησης (τουλάχιστον 15 λεπτά).</p>

LT Lietuviškai	EST Eesti	GR Ελληνικά
<p>▲ PERSPĖJIMAS Netinkamas darbas transportuojant ir montuojant! Susižalojimo pavojus!</p> <p>Naudokite tinkamus montavimo ir transportavimo įrenginius.</p> <p>Naudokite tinkamus įrankius ir asmens saugos priemones.</p>	<p>▲ ETTEVAATUSTI Asjatundmatu käsitsemine transportimisel ja montaažil! Vigastusoht!</p> <p>Kasutage sobivaid montaaži- ja transportiseadiseid.</p> <p>Kasutage sobivaid tööriistu ja isiklikku kaitsevarustust.</p>	<p>▲ ΠΡΟΣΟΧΗ Ακατάλληλος χειρισμός κατά τη μεταφορά και συναρμολόγηση! Κίνδυνος τραυματισμού!</p> <p>Χρησιμοποιείτε κατάλληλους μηχανισμούς συναρμολόγησης και μεταφοράς.</p> <p>Χρησιμοποιείτε κατάλληλα εργαλεία και ατομικό εξοπλισμό προστασίας.</p>
<p>▲ PERSPĖJIMAS Netinkamas darbas su baterijomis! Susižalojimo pavojus!</p> <p>Nebandykite tuščią bateriją reaktivuoti arba įkrauti (sprogimo ir išėsdinimo pavojus).</p> <p>Neardykite ir nepažeiskite baterijų.</p> <p>Nemeskite baterijų į ugnį.</p>	<p>▲ ETTEVAATUSTI Patareide asjatundmatu käsitsemine! Vigastusoht!</p> <p>Ärge üritage kunagi tühje patareisid reaktiveerida või täis laadida (plahvatus- ja söövitusoht).</p> <p>Ärge demonteerige ega kahjustage patareisid. Ärge visake patareisid tulle.</p>	<p>▲ ΠΡΟΣΟΧΗ Ακατάλληλος χειρισμός μπαταριών! Κίνδυνος τραυματισμού!</p> <p>Μην επιδιώκετε να ενεργοποιήσετε ξανά ή να φορτίσετε κενές μπαταρίες (κίνδυνος έκρηξης και διάβρωσης).</p> <p>Μην διαλύετε ή καταστρέφετε τις μπαταρίες. Μην απορρίπτετε τις μπαταρίες στη φωτιά.</p>

CN 中文
<p>▲ 警告 如果不按照下述指定的安全说明使用，将会导致人身伤害！</p> <p>在没有阅读，理解随本产品附带的文件并熟知正当使用前，不要安装或使用本产品。</p> <p>如果没有您所在国家官方语言文件说明，请与 Rexroth 销售伙伴联系。</p> <p>只允许有资格人员对驱动器部件进行操作。</p> <p>安全说明的详细解释在本文档的第一章。</p>
<p>▲ 警告 高压！电击导致生命危险！</p> <p>只有在安装了永久良好的设备接地导线后才可以对驱动器的部件进行操作。</p> <p>在接触驱动器部件前先将驱动器部件断电。</p> <p>确保电容放电时间。</p>
<p>▲ 警告 危险运动！生命危险！</p> <p>保证设备的运动区域内和移动部件周围无障碍物。</p> <p>防止人员意外进入设备运动区域内。</p> <p>在接近或进入危险区域之前，确保传动设备安全停止。</p>
<p>▲ 警告 电磁场/磁场！对佩戴心脏起搏器、金属植入物和助听器的人员会造成严重的人身伤害！</p> <p>上述人员禁止进入安装及运行的驱动器区域，或者必须事先咨询医生。</p>
<p>▲ 小心 热表面（大于 60 度）！灼伤风险！</p> <p>不要触摸金属表面（例如散热器）。驱动器部件断电后需要时间进行冷却（至少 15 分钟）。</p>
<p>▲ 小心 安装和运输不当导致受伤危险！当心受伤！</p> <p>使用适当的运输和安装设备。</p> <p>使用适合的工具及用适当的防护设备。</p>
<p>▲ 小心 电池操作不当！受伤风险！</p> <p>请勿对低电量电池重新激活或重新充电（爆炸和腐蚀的危险）。</p> <p>请勿拆解或损坏电池。请勿将电池投入明火中。</p>

Table of Contents

	Page
1	Important Notes..... 13
1.1	Safety Instructions..... 13
1.1.1	General Information..... 13
1.1.2	Protection Against Contact With Electrical Parts and Housings..... 14
1.1.3	Protection Against Dangerous Movements..... 15
1.1.4	Protection Against Magnetic and Electromagnetic Fields During Operation and Mounting..... 17
1.1.5	Protection Against Contact With Hot Parts..... 17
1.1.6	Protection During Handling and Mounting..... 17
1.1.7	Battery Safety..... 18
1.2	Appropriate Use..... 18
2	Identification..... 21
2.1	Type Code..... 21
2.2	Type Plates..... 22
2.3	Scope of Supply..... 22
3	Ratings and Dimensions..... 23
4	Documentations..... 25
4.1	Drive Systems, System Components..... 25
4.2	Motors..... 25
4.3	Cables..... 26
4.4	Firmware..... 26
5	Instructions for Use..... 29
5.1	Overcurrent Protection..... 29
5.2	Connection Points..... 29
5.2.1	Wiring Diagram..... 29
5.2.2	Connection Diagram..... 30
5.2.3	X3, Mains Connection..... 31
	Important Notes..... 31
	HCS02.1E-W0012, -W0028..... 32
	HCS02.1E-W0054, -W0070..... 32
5.2.4	X5, Motor Connection..... 33
	Important Notes..... 33
	HCS02.1E-W0012, -W0028..... 33
	HCS02.1E-W0054, -W0070..... 34
5.2.5	X6, Motor Temperature Monitoring and Motor Holding Brake..... 34
5.2.6	X9, External Braking Resistor..... 37
	Important Notes..... 37
	X9, External Braking Resistor HCS02.1E-W0054 and -W0070..... 38
5.2.7	X13, Control Voltage (24V, 0V)..... 39
5.2.8	L+ L-, DC Bus Connection..... 41

Table of Contents

	Page
5.2.9	Ground Connection..... 43
5.2.10	Shield Connection..... 43
	XS1, Shield Connection Control Lines..... 43
	XS2, Shield Connection Motor Cable..... 44
5.3	Installation..... 44
5.3.1	General Information on How to Install the Drive Controller..... 44
5.3.2	Sizing of Enclosure and Control Cabinet..... 46
	Multiple-Line Design of the Control Cabinet..... 46
	Arranging the Cooling Units..... 47
6	EMC Measures for Design and Installation..... 49
6.1	Rules for Design of Installations With Drive Controllers in Compliance With EMC..... 49
6.2	EMC-Optimal Installation in Facility and Control Cabinet..... 50
6.2.1	General Information..... 50
6.2.2	Division Into Areas (Zones)..... 50
6.2.3	Control Cabinet Design According to Interference Areas - Exemplary Arrangements..... 52
6.2.4	Design and Installation in Area A - Interference-Free Area of Control Cabinet..... 53
6.2.5	Design and Installation in Area B - Interference-Susceptible Area of Control Cabinet..... 55
6.2.6	Design and Installation in Area C - Strongly Interference-Susceptible Area of Control Cabinet..... 55
6.3	Ground Connections..... 56
6.4	Installing Signal Lines and Signal Cables..... 57
6.5	General Measures of Radio Interference Suppression for Relays, Contactors, Switches, Chokes and Inductive Loads..... 58
7	Accessories..... 59
7.1	Overview..... 59
7.2	Information on Accessory HAS02..... 60
8	Service and Support..... 61
9	Environmental Protection and Disposal 63
9.1	Environmental Protection..... 63
9.2	Disposal..... 63
	Index..... 65

1 Important Notes

1.1 Safety Instructions

1.1.1 General Information

- Do not attempt to install and operate the components of the electric drive and control system without first reading all documentation provided with the product. Read and understand these safety instructions and all user documentation prior to working with these components. If you do not have the user documentation for the components, contact your responsible Rexroth sales partner. Ask for these documents to be sent immediately to the person or persons responsible for the safe operation of the components.
- If the supplied documents contain some information you do not understand, it is absolutely necessary that you ask Rexroth for explanation before you start working at or with the components.
- If the component is resold, rented and/or passed on to others in any other form, these safety instructions must be delivered with the component in the official language of the user's country.
- Only qualified persons may work with components of the electric drive and control system or within its proximity.

In terms of this Instruction Manual, qualified persons are those persons who are familiar with the installation, mounting, commissioning and operation of the components of the electric drive and control system, as well as with the hazards this implies, and who possess the qualifications their work requires. To comply with these qualifications, it is necessary, among other things,

- to be trained, instructed or authorized to switch electric circuits and components safely on and off, to ground them and to mark them,
- to be trained or instructed to maintain and use adequate safety equipment,
- to attend a course of instruction in first aid.
- The technical data, connection and installation conditions of the components are specified in the respective application documentations and must be followed at all times.
- If the components take the form of hardware, then they must remain in their original state, in other words, no structural changes are permitted. It is not permitted to decompile software components or alter source codes.
- Do not mount damaged or faulty components or use them in operation.
- Only use accessories and spare parts approved by Rexroth.
- Follow the safety regulations and requirements of the country in which the electric components of the electric drive and control system are operated.
- Proper and correct transport, storage, mounting and installation, as well as care in operation and maintenance, are prerequisites for optimal and safe operation of the component.

Improper use of these components, failure to follow the safety instructions in this document or tampering with the product, including disabling of safety devices, could result in property damage, injury, electric shock or even death.

Important Notes

1.1.2 Protection Against Contact With Electrical Parts and Housings



This section concerns components of the electric drive and control system with voltages of **more than 50 volts**.

Contact with parts conducting voltages above 50 volts can cause personal danger and electric shock. When operating components of the electric drive and control system, it is unavoidable that some parts of these components conduct dangerous voltage.

High electrical voltage! Danger to life, risk of injury by electric shock or serious injury!

- Only qualified persons are allowed to operate, maintain and/or repair the components of the electric drive and control system.
- Follow the general installation and safety regulations when working on power installations.
- Before switching on, the equipment grounding conductor must have been permanently connected to all electric components in accordance with the connection diagram.
- Even for brief measurements or tests, operation is only allowed if the equipment grounding conductor has been permanently connected to the points of the components provided for this purpose.
- Before accessing electrical parts with voltage potentials higher than 50 V, you must disconnect electric components from the mains or from the power supply unit. Secure the electric component from reconnection.
- With electric components, observe the following aspects:
 - Always wait **30 minutes** after switching off power to allow live capacitors to discharge before accessing an electric component. Measure the electrical voltage of live parts before beginning to work to make sure that the equipment is safe to touch.
- Install the covers and guards provided for this purpose before switching on.
- Never touch electrical connection points of the components while power is turned on.
- Do not remove or plug in connectors when the component has been powered.
- Under specific conditions, electric drive systems can be operated at mains protected by residual-current-operated circuit-breakers sensitive to universal current (RCDs/RCMs).
- Secure built-in devices from penetrating foreign objects and water, as well as from direct contact, by providing an external housing, for example a control cabinet.

High housing voltage and high leakage current! Danger to life, risk of injury by electric shock!

- Before switching on and before commissioning, ground or connect the components of the electric drive and control system to the equipment grounding conductor at the grounding points.

Important Notes

- Connect the equipment grounding conductor of the components of the electric drive and control system permanently to the main power supply at all times. The leakage current is greater than 3.5 mA.
- Establish an equipment grounding connection with a minimum cross section according to the table below. With an outer conductor cross section smaller than 10 mm² (8 AWG), the alternative connection of two equipment grounding conductors is allowed, each having the same cross section as the outer conductors.

Cross section outer conductor	Minimum cross section equipment grounding conductor Leakage current ≥ 3.5 mA	
	1 equipment grounding conductor	2 equipment grounding conductors
1,5 mm ² (AWG 16)	10 mm ² (AWG 8)	2 × 1,5 mm ² (AWG 16)
2,5 mm ² (AWG 14)		2 × 2,5 mm ² (AWG 14)
4 mm ² (AWG 12)		2 × 4 mm ² (AWG 12)
6 mm ² (AWG 10)		2 × 6 mm ² (AWG 10)
10 mm ² (AWG 8)		-
16 mm ² (AWG 6)	16 mm ² (AWG 6)	-
25 mm ² (AWG 4)		-
35 mm ² (AWG 2)		-
50 mm ² (AWG 1/0)	25 mm ² (AWG 4)	-
70 mm ² (AWG 2/0)	35 mm ² (AWG 2)	-
...

Fig. 1-1: Minimum Cross Section of the Equipment Grounding Connection

1.1.3 Protection Against Dangerous Movements

Dangerous movements can be caused by faulty control of connected motors. Some common examples are:

- Improper or wrong wiring or cable connection
- Operator errors
- Wrong input of parameters before commissioning
- Malfunction of sensors and encoders
- Defective components
- Software or firmware errors

These errors can occur immediately after equipment is switched on or even after an unspecified time of trouble-free operation.

The monitoring functions in the components of the electric drive and control system will normally be sufficient to avoid malfunction in the connected drives. Regarding personal safety, especially the danger of injury and/or property damage, this alone cannot be relied upon to ensure complete safety. Until the integrated monitoring functions become effective, it must be assumed in any case that faulty drive movements will occur. The extent of faulty drive movements depends upon the type of control and the state of operation.

Important Notes

Dangerous movements! Danger to life, risk of injury, serious injury or property damage!

A **risk assessment** must be prepared for the installation or machine, with its specific conditions, in which the components of the electric drive and control system are installed.

As a result of the risk assessment, the user must provide for monitoring functions and higher-level measures on the installation side for personal safety. The safety regulations applicable to the installation or machine must be taken into consideration. Unintended machine movements or other malfunctions are possible if safety devices are disabled, bypassed or not activated.

To avoid accidents, injury and/or property damage:

- Keep free and clear of the machine's range of motion and moving machine parts. Prevent personnel from accidentally entering the machine's range of motion by using, for example:
 - Safety fences
 - Safety guards
 - Protective coverings
 - Light barriers
- Make sure the safety fences and protective coverings are strong enough to resist maximum possible kinetic energy.
- Mount emergency stopping switches in the immediate reach of the operator. Before commissioning, verify that the emergency stopping equipment works. Do not operate the machine if the emergency stopping switch is not working.
- Prevent unintended start-up. Isolate the drive power connection by means of OFF switches/OFF buttons or use a safe starting lockout.
- Make sure that the drives are brought to safe standstill before accessing or entering the danger zone.
- Additionally secure vertical axes against falling or dropping after switching off the motor power by, for example,
 - mechanically securing the vertical axes,
 - adding an external braking/arrester/clamping mechanism or
 - ensuring sufficient counterbalancing of the vertical axes.
- The standard equipment **motor holding brake** or an external holding brake controlled by the drive controller is **not sufficient to guarantee personal safety!**
- Disconnect electrical power to the components of the electric drive and control system using the master switch and secure them from reconnection ("lock out") for:
 - Maintenance and repair work
 - Cleaning of equipment
 - Long periods of discontinued equipment use
- Prevent the operation of high-frequency, remote control and radio equipment near components of the electric drive and control system and their supply leads. If the use of these devices cannot be avoided, check the machine or installation, at initial commissioning of the electric drive and control system, for possible malfunctions when operating such high-frequency, remote control and radio equipment in its possible positions of

normal use. It might possibly be necessary to perform a special electromagnetic compatibility (EMC) test.

1.1.4 Protection Against Magnetic and Electromagnetic Fields During Operation and Mounting

Magnetic and electromagnetic fields generated by current-carrying conductors or permanent magnets of electric motors represent a serious danger to persons with heart pacemakers, metal implants and hearing aids.

Health hazard for persons with heart pacemakers, metal implants and hearing aids in proximity to electric components!

- Persons with heart pacemakers and metal implants are not allowed to enter the following areas:
 - Areas in which components of the electric drive and control systems are mounted, commissioned and operated.
 - Areas in which parts of motors with permanent magnets are stored, repaired or mounted.
- If it is necessary for somebody with a heart pacemaker to enter such an area, a doctor must be consulted prior to doing so. The noise immunity of implanted heart pacemakers differs so greatly that no general rules can be given.
- Those with metal implants or metal pieces, as well as with hearing aids, must consult a doctor before they enter the areas described above.

1.1.5 Protection Against Contact With Hot Parts

Hot surfaces of components of the electric drive and control system. Risk of burns!

- Do not touch hot surfaces of, for example, braking resistors, heat sinks, supply units and drive controllers, motors, windings and laminated cores!
- According to the operating conditions, temperatures of the surfaces can be **higher than 60 °C** (140 °F) during or after operation.
- Before touching motors after having switched them off, let them cool down for a sufficient period of time. Cooling down can require **up to 140 minutes!** The time required for cooling down is approximately five times the thermal time constant specified in the technical data.
- After switching chokes, supply units and drive controllers off, wait **15 minutes** to allow them to cool down before touching them.
- Wear safety gloves or do not work at hot surfaces.
- For certain applications, and in accordance with the respective safety regulations, the manufacturer of the machine or installation must take measures to avoid injuries caused by burns in the final application. These measures can be, for example: Warnings at the machine or installation, guards (shieldings or barriers) or safety instructions in the application documentation.

1.1.6 Protection During Handling and Mounting

Risk of injury by improper handling! Injury by crushing, shearing, cutting, hitting!

Important Notes

- Observe the relevant statutory regulations of accident prevention.
- Use suitable equipment for mounting and transport.
- Avoid jamming and crushing by appropriate measures.
- Always use suitable tools. Use special tools if specified.
- Use lifting equipment and tools in the correct manner.
- Use suitable protective equipment (hard hat, safety goggles, safety shoes, safety gloves, for example).
- Do not stand under hanging loads.
- Immediately clean up any spilled liquids from the floor due to the risk of falling!

1.1.7 Battery Safety

Batteries consist of active chemicals in a solid housing. Therefore, improper handling can cause injury or property damage.

Risk of injury by improper handling!

- Do not attempt to reactivate low batteries by heating or other methods (risk of explosion and cauterization).
- Do not attempt to recharge the batteries as this may cause leakage or explosion.
- Do not throw batteries into open flames.
- Do not dismantle batteries.
- When replacing the battery/batteries, do not damage the electrical parts installed in the devices.
- Only use the battery types specified for the product.



Environmental protection and disposal! The batteries contained in the product are considered dangerous goods during land, air, and sea transport (risk of explosion) in the sense of the legal regulations. Dispose of used batteries separately from other waste. Observe the national regulations of your country.

1.2 Appropriate Use

This product may only be used for the applications mentioned in the additional documentations (see index entry "Additional documentations") and under the described application, ambient and operating conditions.

This product is exclusively intended for use in machines and systems in an industrial environment. This is to be understood as applications according to IEC 60204-1 "Safety of machinery, Electric equipment of machines" and NFPA 79 "Electrical Standard for Industrial Machinery".

Important Notes



Components of the Rexroth IndraDrive system are **products of category C3** (with limited availability) according to IEC 61800-3. To ensure that this category (limit values) is maintained, suitable line filters must be used in the drive system.

These components are not provided for use in a public low-voltage network supplying residential areas with power. If these components are used in such a public network, high-frequency interference is to be expected. This can require additional measures of radio interference suppression.

Identification

2.2 Type Plates

Type Plate (Example)

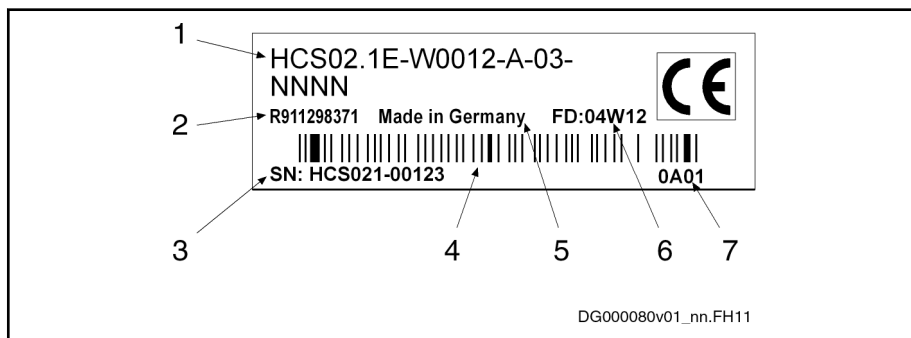

- | | |
|---|---|
| 1 | Device type |
| 2 | Part number |
| 3 | Serial number |
| 4 | Bar code |
| 5 | Country of manufacture |
| 6 | Production week, 04W12 meaning year 2004, week 12 |
| 7 | Hardware index |

Fig.2-2: Type Plate - Power Section (Example of an HCS02 Power Section)

2.3 Scope of Supply

The scope of supply includes:

- touch guard
- connector X3, X5, X6, X13, X9 each (for designs W0054 and W0070)
- documentation

3 Ratings and Dimensions

UL Ratings and Dimensions

Description	Symbol	Unit	HCS02.1E- W0012-_-03	HCS02.1E- W0028-_-03	HCS02.1E- W0054-_-03	HCS02.1E- W0070-_-03
Listing according to UL standard (UL)			UL 508 C			
Listing according to CSA standard (UL)			Canadian National Standard(s) C22.2 No. 14-10			
UL files (UL)			E 134201			
Pollution degree (UL)			2			
Ambient temperature with nominal data (UL)	T_{amax}	°C	40			
Ambient temperature with reduced nominal data (UL)	T_{amax_red}	°C	55			
Mass	m	kg	2,90	3,80	6,70	6,80
Device height (UL) ¹⁾	H	mm	290	352		
Device depth (UL) ²⁾	T	mm	206			
Device width (UL) ³⁾	B	mm	65		105	
Minimum distance on the top of the device ⁴⁾	d_{top}	mm	80			
Minimum distance on the bottom of the device ⁵⁾	d_{bot}	mm	80			
Horizontal spacing on the device ⁶⁾	d_{hor}	mm	5			
Rated control voltage input (UL) ⁷⁾	U_{N3}	V	24 ± 20 %			
Rated power consumption control voltage input at U_{N3} (UL) ⁸⁾	P_{N3}	W	12	14	23	
Short circuit current rating (UL)	SCCR	A rms	42000			
Rated input voltage, power (UL) ⁹⁾	U_{LN_nenn}	V	3 x AC 200...500			
Tolerance rated input voltage (UL)		%	± 10			
Input frequency (UL)	f_{LN}	Hz	50...60			
Tolerance input frequency (UL)		Hz	± 2			
Rated input current (UL)	I_{LN}	A	6,0	13,0	20,0	30,0
Branch circuit protection fuse (UL) ¹⁰⁾			20		25	40
Required wire size according to EN 60204-1 ¹¹⁾	A_{LN}	mm ²	1,5		4	6
Required wire size according to UL 508 A (internal wiring); (UL) ¹²⁾	A_{LN}	AWG	AWG 14		AWG 12	AWG 10

Last modification: 2010-08-04

Ratings and Dimensions

Description	Symbol	Unit	HCS02.1E-W0012-_-03	HCS02.1E-W0028-_-03	HCS02.1E-W0054-_-03	HCS02.1E-W0070-_-03
Field wiring material (material; conductor temperature; class)			Cu; 60/75 °C; 1			
Output voltage (UL)	U_{out}	V	3 x AC 0...530			
Output current (UL)	I_{out}	A	4,5	11,5	22,0	28,0
Output frequency range (UL) ¹³⁾	f_{out}	Hz	0...1600			
Power dissipation at continuous current and continuous DC bus power respectively (UL) ¹⁴⁾	P_{Diss_cont}	W	80,00	130,00	270,00	300,00
Last modification: 2010-08-04						

- 1) 2) 3) Housing dimension; see also related dimensional drawing
- 4) 5) 6) See fig. "Air Intake and Air Outlet at Device"
- 7) Observe supply voltage for motor holding brakes
- 8) HMS, HMD, HCS plus motor holding brake and control section; HCS01 including control section
- 9) DC bus L+, L-; mains input L1, L2, L3
- 10) Use listed AC input line fuses (class J; 600 V AC) or listed circuit breakers (600 V AC) at the mains supply
- 11) Copper wire; PVC-insulation (conductor temperature 70 °C); installation method B1; table 6
- 12) Copper wire; PVC-insulation (conductor temperature 90 °C); table 28.1; $T_a \leq 40$ °C
- 13) Depending on switching frequency which was set in parameter P-0-0001
- 14) Plus dissipation of braking resistor and control section

Fig.3-1: HCS - UL Ratings and Dimensions

Distances

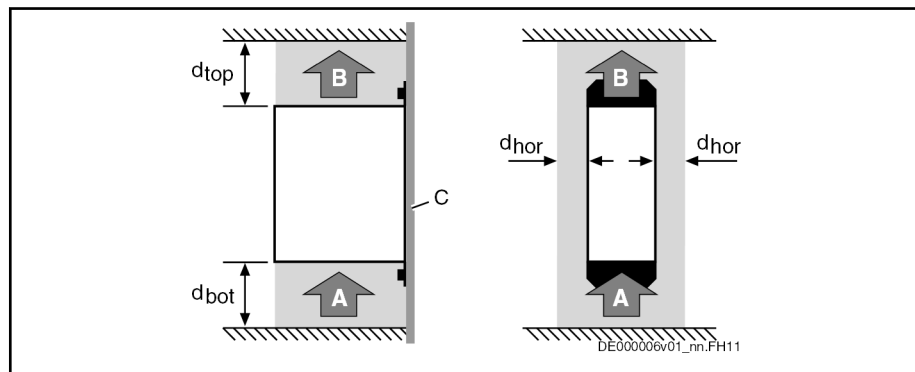

- A Air intake
- B Air outlet
- C Mounting surface in control cabinet
- d_{top} Distance top
- d_{bot} Distance bottom
- d_{hor} Distance horizontal

Fig.3-2: Air Intake and Air Outlet at Device

4 Documentations

4.1 Drive Systems, System Components

Title Rexroth IndraDrive ...	Kind of documentation	Document typecode ¹⁾ DOK-INDRV*-...	Part number R911...
Drive Systems With HMV01/02 HMS01/02, HMD01, HCS02/03	Project Planning Manual	SYSTEM*****-PRxx-EN-P	309636
Mi Drive Systems	Project Planning Manual	KCU+KSM*****-PRxx-EN-P	320924
Supply Units, Power Sections HMV, HMS, HMD, HCS02, HCS03	Project Planning Manual	HMV-S-D+HCS-PRxx-EN-P	318790
Drive Controllers Control Sections CSB01, CSH01, CDB01	Project Planning Manual	CSH*****-PRxx-EN-P	295012
Additional Components and Accessor- ies	Project Planning Manual	ADDCOMP****-PRxx-EN-P	306140
C Drive Controllers HCS02.1, HCS03.1	Operating Instructions	FU*****-IBxx-EN-P	314905

1) In the document typecodes, "xx" is a wild card for the current edition of the documentation (example: PR01 is the first edition of a Project Planning Manual)

Fig.4-1: Documentations – Overview

Title	Kind of documentation	Document typecode ¹⁾	Part number R911...
Automation Terminals Of The Rexroth Inline Product Range	Application Manual	DOK-CONTRL-ILSYSINS***- AWxx-EN-P	317021

1) In the document typecodes, "xx" is a wild card for the current edition of the documentation (example: AW01 is the first edition of an Application Manual)

Fig.4-2: Documentations – Overview

4.2 Motors

Title Rexroth IndraDyn ...	Kind of documentation	Document typecode ¹⁾ DOK-MOTOR*-...	Part number R911...
A Asynchronous Motors MAD / MAF	Project Planning Manual	MAD/MAF****-PRxx-EN-P	295781
H Synchronous Kit Spindle Motors	Project Planning Manual	MBS-H*****-PRxx-EN-P	297895
L Synchronous Linear Motors	Project Planning Manual	MLF*****-PRxx-EN-P	293635
S MSK Synchronous Motors	Project Planning Manual	MSK*****-PRxx-EN-P	296289
T Synchronous Torque Motors	Project Planning Manual	MBT*****-PRxx-EN-P	298798

1) In the document typecodes, "xx" is a wild card for the current edition of the documentation (example: PR01 is the first edition of a Project Planning Manual)

Fig.4-3: Documentations – Overview

Documentations

4.3 Cables

Title	Kind of documentation	Document typecode ¹⁾ DOK-...	Part number R911...
Rexroth Connection Cables IndraDrive and IndraDyn	Selection Data	CONNEX-CABLE*INDRV-CAxx- EN-P	322949

1) In the document typecodes, "xx" is a wild card for the current edition of the documentation (example: CA02 is the second edition of the documentation "Selection Data")

Fig.4-4: Documentations – Overview

4.4 Firmware

Title Rexroth IndraDrive ...	Kind of documentation	Document typecode ¹⁾ DOK-INDRV*-...	Part number R911...
Firmware for Drive Controllers MPH-08, MPB-08, MPD-08, MPC-08	Functional Description	MP*-08VRS**-APxx-EN-P	332643
Firmware for Drive Controllers MPH-07, MPB-07, MPD-07, MPC-07	Functional Description	MP*-07VRS**-FKxx-EN-P	328670
Firmware for Drive Controllers MPH-06, MPB-06, MPD-06, MPC-06	Functional Description	MP*-06VRS**-FKxx-EN-P	326766
Firmware for Drive Controllers MPH-05, MPB-05, MPD-05	Functional Description	MP*-05VRS**-FKxx-EN-P	320182
Firmware for Drive Controllers MPH-04, MPB-04, MPD-04	Functional Description	MP*-04VRS**-FKxx-EN-P	315485
Firmware for Drive Controllers MPH-03, MPB-03, MPD-03	Functional Description	MP*-03VRS**-FKxx-EN-P	308329
Firmware for Drive Controllers MPH-02, MPB-02, MPD-02	Functional Description	MP*-02VRS**-FKxx-EN-P	299223
Drive Controllers MPx-02 to MPx-08	Parameter Description	GEN-**VRS**-PAxx-EN-P	297317
MPx-02 to MPx-08 and HMV	Troubleshooting Guide	GEN-**VRS**-WAxx-EN-P	297319
Integrated Safety Technology	Functional and Application Description	SI*-**VRS**-FKxx-EN-P	297838
Integrated Safety Technology According to IEC61508	Functional Description	SI2-**VRS**-FKxx-EN-P	327664
Rexroth IndraMotion MLD	Application Manual	MLD-**VRS**-AWxx-EN-P	306084
Rexroth IndraMotion MLD Library	Library Description	MLD-SYSLIB*-FKxx-EN-P	309224

1) In the document typecodes, "xx" is a wild card for the current edition of the documentation (example: FK02 is the second edition of a Functional Description)

Fig.4-5: Documentations – Overview

Documentations

Title	Kind of documentation	Document typecode ¹⁾	Part number R911...
Productivity Agent Extended Diagnostic Functions With Rexroth IndraDrive	Application Manual	DOK-INDRV*-MLD-PAGENT* AWxx-EN-P	323947

1) In the document typecodes, "xx" is a wild card for the current edition of the documentation (example: AW01 is the first edition of an Application Manual)

Fig.4-6: Documentations – Overview

5 Instructions for Use

5.1 Overcurrent Protection

Protect the components against overcurrent:

- Branch circuit protection has to be provided externally
- Dimension the branch circuit protection according to the data "Branch circuit protection fuse (UL)" (see Ratings and Dimensions)

5.2 Connection Points

5.2.1 Wiring Diagram

Power section = HCS02

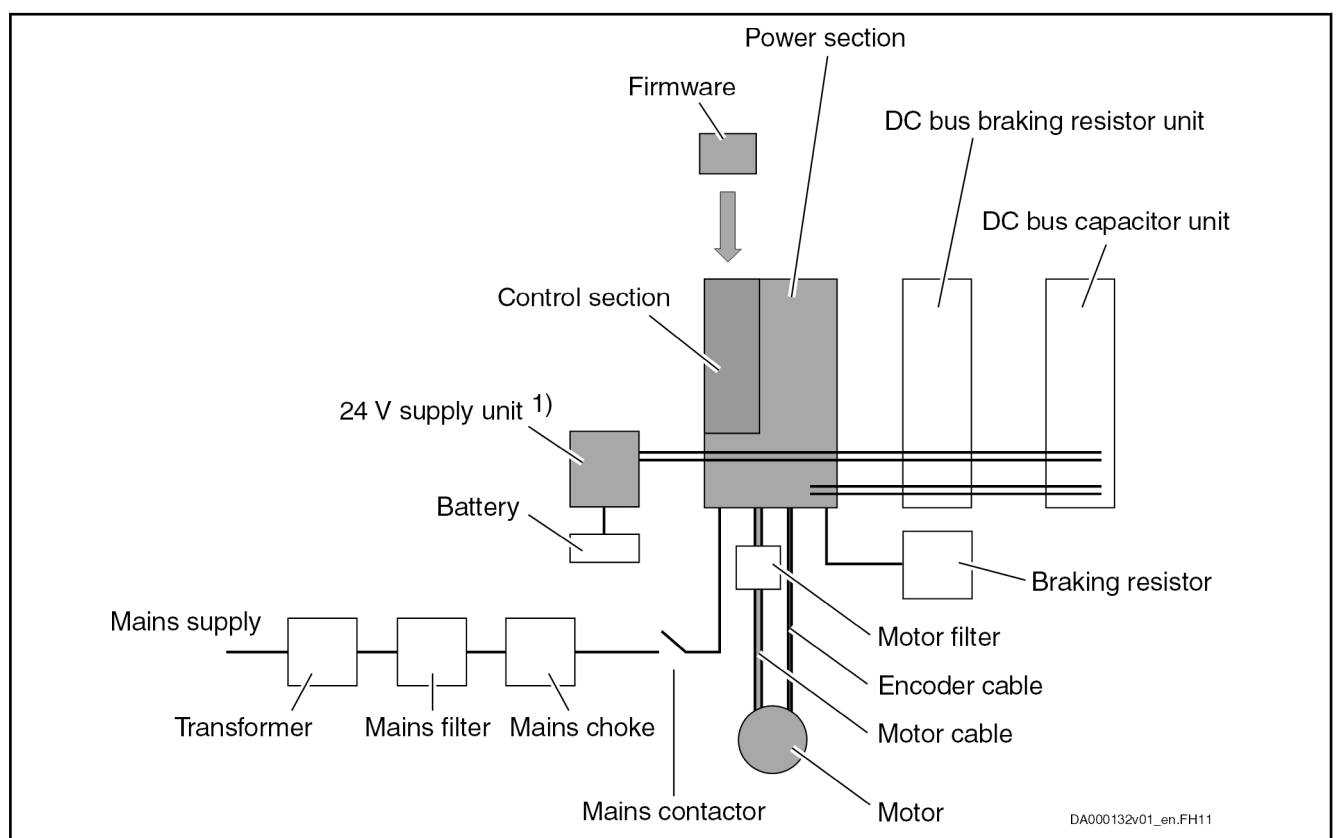

The components marked with gray background color are absolutely necessary.

- 1) 24V power supply unit can be omitted when using devices with integrated 24V power supply (HCS02.1E- or HCS03.1E-...-NNNV with control section CSB01.1N-FU)

Fig.5-1: Drive System Rexroth IndraDrive C

Instructions for Use

5.2.2 Connection Diagram

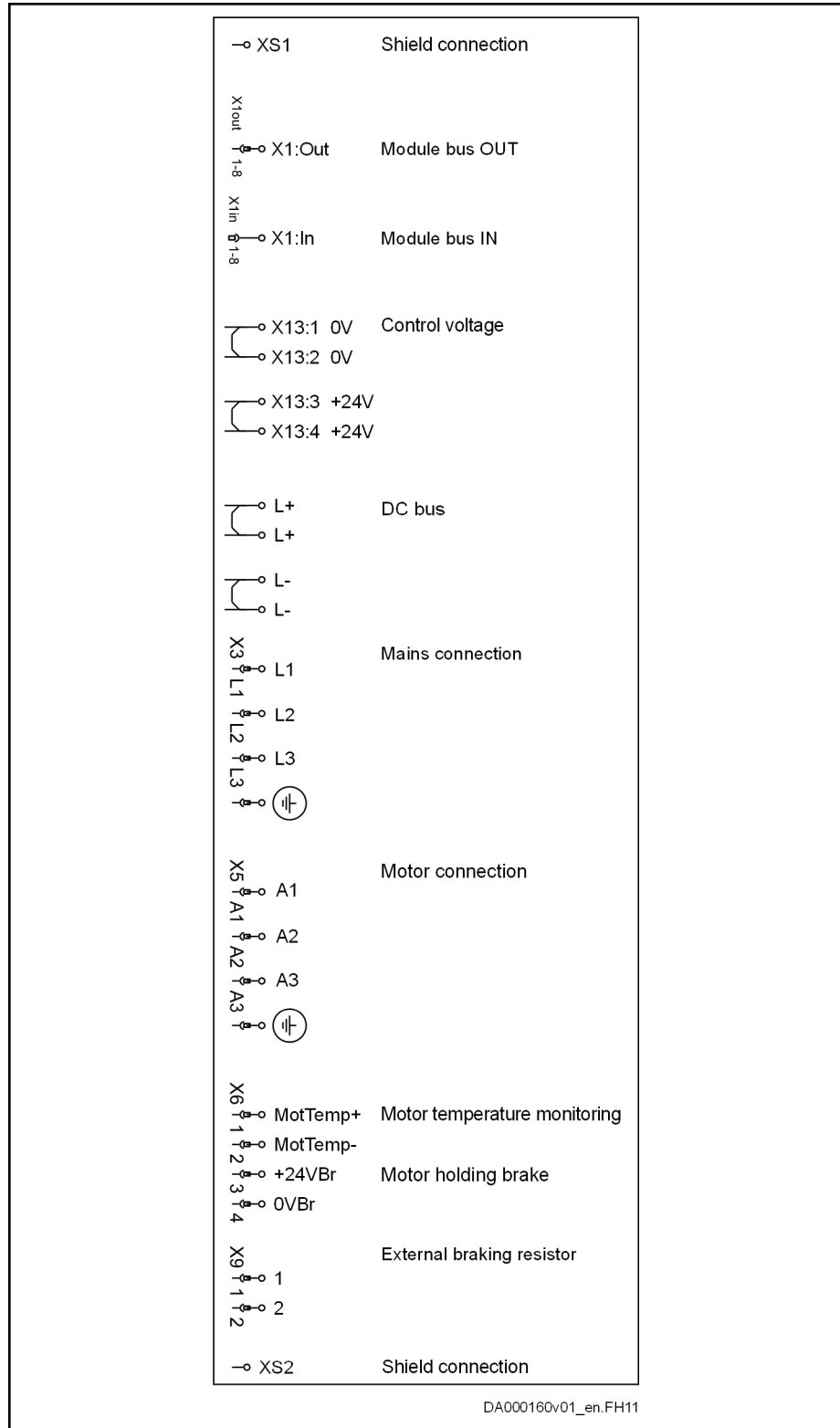

X1, L+/L-
 X9

Not available for HCS02.1E-W0012
 Not available for HCS02.1E-W0012 and -W0028

Fig. 5-2:

Overall Connection Diagram



Apart from the indicated connections, it is necessary to wire the **Bb contact at the control section** for signaling the readiness for operation of the drive controller (see Project Planning Manual "Rexroth IndraDrive Drive Controllers Control Sections").

5.2.3 X3, Mains Connection

Important Notes

⚠ WARNING

Lethal electric shock by live parts with more than 50 V!

Exclusively operate the device

- with plugged on connectors (even if there haven't been any lines connected to the connectors) and
- with connected equipment grounding conductor!

Notes on Installation

Dimension the **required cross section** of the connection cables according to the determined phase current I_{LN} and the mains fuse.



Equipment grounding conductor: Material and cross section

For the equipment grounding conductor, use the same metal (e.g. copper) as for the outer conductors.

For the connections from the equipment grounding conductor connection of the device to the equipment grounding conductor system in the control cabinet, make sure the cross sections of the lines are sufficient.

Cross sections of the equipment grounding connections:

- For **HCS03.1E** drive controllers, **HMV01** and **HMV02** supply units at least **10 mm² (AWG 8)**, but not smaller than the cross sections of the outer conductors of the mains supply feeder
- For **HCS02.1E** drive controllers, **at least 4 mm² (AWG 10)**, but not smaller than the cross sections of the outer conductors of the mains supply feeder

Additionally, mount the housing of HCS02.1E to a bare metal mounting plate. Connect the mounting plate, too, with at least the same cross section to the equipment grounding conductor system in the control cabinet.

For outer conductors with a cross section greater than 16 mm², you can reduce the cross section of the equipment grounding connection according to the table "Equipment Grounding Conductor Cross Section".

Cross-sectional area A of outer conductors	Minimum cross-sectional area A _{PE} of equipment grounding connection
$A \leq 16 \text{ mm}^2$	A
$16 \text{ mm}^2 < A \leq 35 \text{ mm}^2$	16
$35 \text{ mm}^2 < A$	$A / 2$

Fig. 5-3: Equipment Grounding Conductor Cross Section

Instructions for Use

NOTICE**Damage to the device!**

Provide strain relief for the terminal connectors of the device in the control cabinet or use the optionally available connection accessory HAS02.

HCS02.1E-W0012, -W0028





View	Identification	Function 3-phase operation	Function 1-phase operation
 <p>DA000179v01_nn.FH11</p>	L1	Connection to supply mains (L1)	
	L2	Connection to supply mains (L2)	Connection to neutral conductor supply mains
	L3	Connection to supply mains (L3)	n.c.
		Connection of equipment grounding conductor of drive controller	
Screw connection at connector	Unit	Min.	Max.
Tightening torque	Nm	0,5	0,6
Connection cross section	mm ²	1,5	4
Stranded wire	AWG	16	10
Occurring current load and minimum required connection cross section		See technical data of device used (I_{LN} and A_{LN})	
Occurring voltage load		See technical data of device used (U_{LN})	

Fig.5-4: Function, Pin Assignment, Properties

HCS02.1E-W0054, -W0070

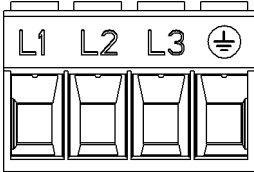
View	Identification	Function 3-phase operation	Function 1-phase operation (only HCS02.1E)
 <p>DA000179v01_nn.FH11</p>	L1	Connection to supply mains (L1)	
	L2	Connection to supply mains (L2)	Connection to neutral conductor supply mains
	L3	Connection to supply mains (L3)	n.c.
		Connection of equipment grounding conductor of drive controller	
Screw connection at connector	Unit	Min.	Max.
Tightening torque	Nm	1,5	1,7
Connection cross section	mm ²	1,5	16
Stranded wire	AWG	16	6

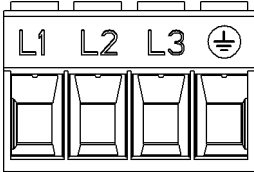
Occurring current load and minimum required connection cross section		See technical data of device used (I_{LN} and A_{LN})
Occurring voltage load		See technical data of device used (U_{LN} or U_{LN_nenn})

Fig.5-5: Function, Pin Assignment, Properties

5.2.4 X5, Motor Connection

Important Notes

⚠ WARNING

Lethal electric shock by live parts with more than 50 V!

Exclusively operate the device

- with plugged on connectors (even if there haven't been any lines connected to the connectors) and
- with connected equipment grounding conductor!

⚠ CAUTION

Damage to the device!

Provide strain relief for the terminal connectors of the device in the control cabinet or use the optionally available connection accessory HAS02.

Notes on Installation

The indicated connection cross sections are the cross sections which can be connected. Dimension the **required cross section** of the connecting lines according to the occurring current load.



- For optimum shield contact of the motor power cable, use our accessory HAS02, where possible.
- For the connection between drive controller and motor use our ready-made motor power cables, where possible (see documentation "Rexroth Connection Cables").
- When using NFD03.1 mains filters, the maximum allowed conductor cross section is limited to 4 mm².
- For selecting the motor cables, observe the information contained in the Project Planning Manual "Rexroth IndraDrive Drive System" → "Connection Cables to Motor".

HCS02.1E-W0012, -W0028

View	Identification	Function	
<p>DA000173v01_nn.FH11</p>	A1	For power connection U1 at motor	
	A2	For power connection V1 at motor	
	A3	For power connection W1 at motor	
		For equipment grounding conductor of motor	
Screw connection at connector	Unit	Min.	Max.
Tightening torque	Nm	0,5	0,6

Instructions for Use

Connection cable Stranded wire	mm ²	1,0	4
	AWG	18	10
Occurring current load and minimum required connection cross section	A	See technical data of device used (I_{out})	
Occurring voltage load	V	See technical data of device used (U_{out})	
Short circuit protection		A1, A2, A3 against each other and each of them against ground	

Fig.5-6: Function, Pin Assignment, Properties

HCS02.1E-W0054, -W0070



View	Identification	Function	
 <p>DA000173v01_nn.FH11</p>	A1	For power connection U1 at motor	
	A2	For power connection V1 at motor	
	A3	For power connection W1 at motor	
		For equipment grounding conductor of motor	
Screw connection at connector	Unit	Min.	Max.
Tightening torque	Nm	1,5	1,7
Connection cable Stranded wire	mm ²	1,5	16
	AWG	16	6
Occurring current load and minimum required connection cross section	A	See Technical Data of device used (I_{out})	
Occurring voltage load	V	See Technical Data of device used (U_{out})	
Short circuit protection		A1, A2, A3 against each other and each of them against ground	

Fig.5-7: Function, Pin Assignment, Properties

5.2.5 X6, Motor Temperature Monitoring and Motor Holding Brake

⚠ WARNING

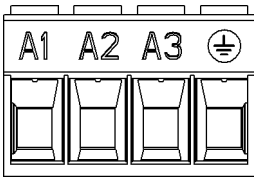
Lethal electric shock by live parts with more than 50 V!

Exclusively operate the device

- with plugged on connectors (even if there haven't been any lines connected to the connectors) and
- with connected equipment grounding conductor!

⚠ WARNING Dangerous movements! Danger to persons from falling or dropping axes!

The standard motor holding brake provided or an external motor holding brake controlled directly by the drive controller are not sufficient on their own to guarantee personal safety!

Personal safety must be achieved using higher-level, fail-safe measures:

- Block off danger zones with safety fences or safety guards
- Additionally secure vertical axes against falling or dropping after switching off the motor power by, for example,
 - mechanically securing the vertical axes
 - adding external braking/arrester/clamping mechanisms
 - ensuring sufficient equilibration of the vertical axes

Function The connection point X6 contains the connections for

- monitoring the motor temperature
- controlling the motor holding brake



Via an integrated contact element (BR), the power section switches the voltage of the **external** 24V supply (connection X13 at HCS02 power sections) to the output for controlling the motor holding brake.

The integrated 24V control voltage supply of power sections of the order code **-NxxV** is not available at the connection point X6 (see figure below "Block Diagram of Internal Control Voltage"). Therefore, an **external** 24V supply is required for controlling the motor holding brake.

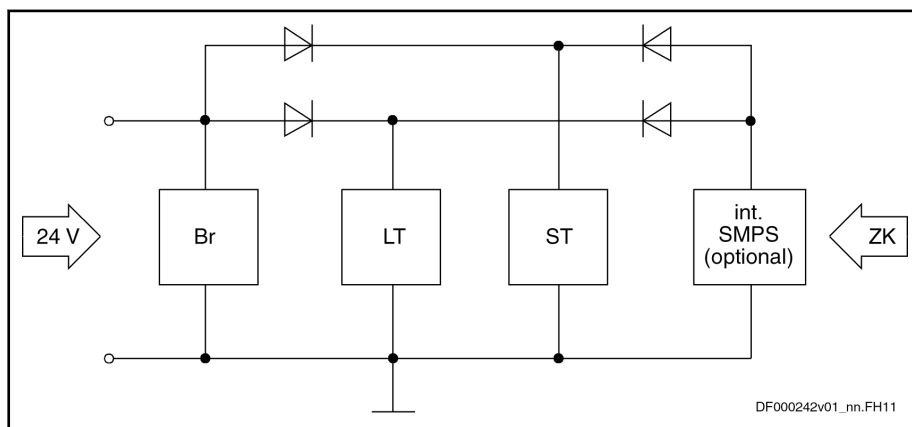

- BR Circuit for brake control
- LT Power section, e.g. HCS02
- ST Control section, e.g. CSB01
- int. SMPS For types HCS0x.1E-Wxxxx-NxxV: Internal switched-mode power supply
- ZK DC bus

Fig. 5-8: Block Diagram of Internal Control Voltage

Instructions for Use

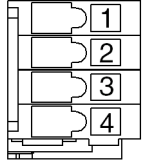
View	Con- nec- tion	Signal name	Function
 DG000097v01_nn.FH11	1	MotTemp+	Input motor temperature evaluation
	2	MotTemp-	
	3	+24V	Output for controlling the motor holding brake
	4	0V	
Spring terminal (connector)	Unit	Min.	Max.
Connection cable solid wire	mm ²	0,5	1,5
Connection cable stranded wire	mm ²	0,5	1,5
	AWG	20	16
Current carrying capacity X6.3, X6.4:			
HCS02.1E-W0012; -W0028; -W0054; -W0070	A	-	2
Number of switching actions of integrated contact element for controlling motor holding brake		HCS02: > 250,000; electromechanical contact	
Time constant of load ¹⁾	ms	-	50
Switching frequency	Hz	-	0,5
Short circuit protection		X6.3 against X6.4 (output for controlling the motor holding brake)	
Overload protection		X6.3 against X6.4 (output for controlling the motor holding brake)	

1) Maximum time constant of load: $t = R_{Br} / L_{Br}$ (R_{Br} = resistance of brake; L_{Br} = inductance of brake)

Fig.5-9: Function, Pin Assignment

Connection Diagram

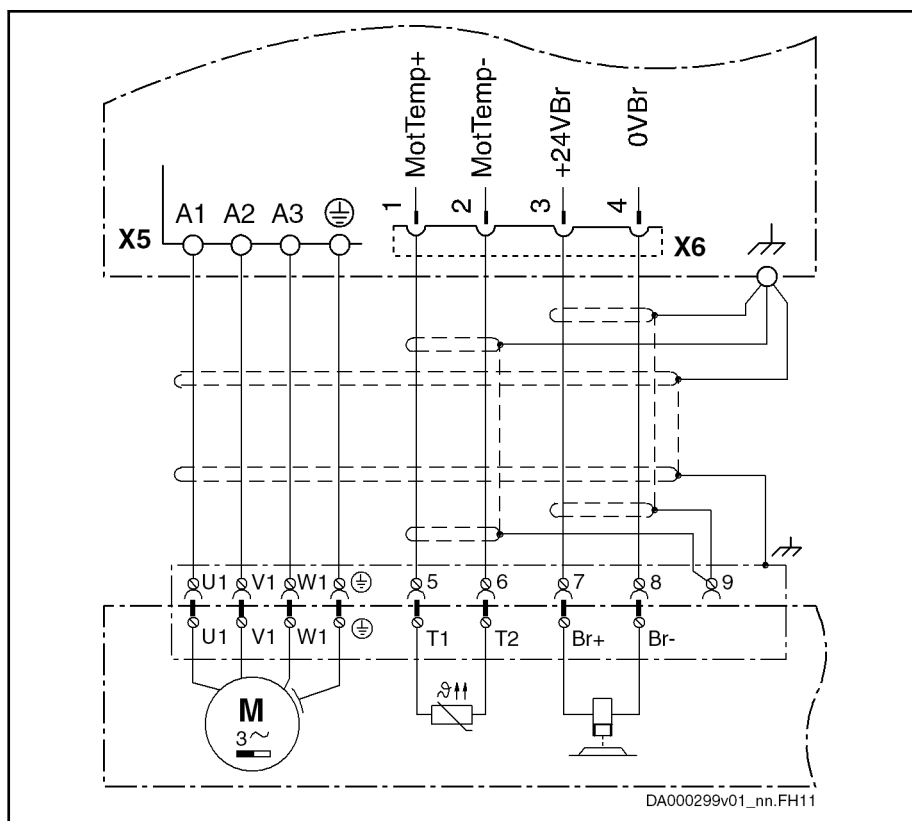

The connection of the equipment grounding conductor can either be at terminal connector X5 or directly at the drive controller (this figure shows a terminal connector X5 with connection of the equipment grounding conductor).

Fig.5-10: Connection of Motor Temperature Monitoring and Motor Holding Brake

Notes on Installation



Make sure the voltage supply for the motor holding at the motor brake is sufficient. You have to take into account that voltage drops on the supply line. Use connecting lines with the highest possible cross section of the single strands.



An external contact element is required, if motor holding brakes with higher currents than the allowed current load are to be supplied at X6.

5.2.6 X9, External Braking Resistor

Important Notes

⚠ WARNING

Lethal electric shock by live parts with more than 50 V!

Exclusively operate the device

- with plugged on connectors (even if there haven't been any lines connected to the connectors) and
- with connected equipment grounding conductor!

Instructions for Use



The external braking resistor must be **parameterized** via the firmware to protect the drive controller and the braking resistor against overload.

See also Parameter Description of the firmware used:

"P-0-0860, Converter configuration"

and

"P-0-0858, Data of external braking resistor"

The drive controller monitors the operating data of the external braking resistor against the data in "P-0-0858, Data of external braking resistor". Select braking resistors with a performance that corresponds to the parameterized values or more powerful braking resistors.

X9, External Braking Resistor HCS02.1E-W0054 and -W0070

Function, Pin Assignment X9 is used to connect an external braking resistor which is controlled via the internal switch.

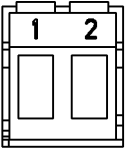

For HCS02 devices, the connection X9 is contained in all designs, except for -W0012 and -W0028.

View	Connection	Signal name	Function
 DA000178v01_nn.FH11	1	n.s.	Connection braking resistor
	2	n.s.	Connection braking resistor
Screw terminal (connector)	Unit	Min.	Max.
Connection line	mm ²	2,5	4
Stranded wire	AWG	14	10
Tightening torque	Nm	1,5	1,7
Current load	A	Peak value: 30 R.m.s. value: 15	
Voltage load	V	n.s.	
Short circuit protection		To be ensured by means of appropriate fusing elements in the mains connection at X3	

n.s. Not specified

Fig. 5-11: Function, Pin Assignment

Notes on Installation

Maximum allowed line length to external braking resistor: **5 m**

Twist unshielded lines.

⚠ WARNING

Lethal electric shock by live parts with more than 50 V!

Risk of burns by hot housing surfaces! Risk of fire!

The temperature of the housing surface of an external HLR braking resistor can rise up to 150 °C. Run the connection lines with a sufficient distance (> 200 mm) to the housing of the HLR braking resistor to avoid damaging the insulation of the connection lines. Outside of the control cabinet, run the connection lines of an HLR braking resistor in a metal pipe with a wall thickness of at least 1 mm.

Do not touch hot housing surfaces! Mount the HLR braking resistor on a temperature-resistant mounting surface. Provide a sufficient distance between the HLR braking resistor and heat-sensitive materials. Make sure the cooling air supply is unrestricted. Take care that the environment can discharge the dissipation heat.

NOTICE

Danger by insufficient installation!

Protect the lines with the appropriate fusing elements in the supply feeder.

For the connection lines at X9, use at least the cross section of the lines for mains connection at X3. If this is impossible, select the cross section of the connection line at X9 in accordance with the continuous power of the braking resistor.

5.2.7 X13, Control Voltage (24V, 0V)

Function, Pin Assignment The external 24V supply is applied via connection point X13 for

- the power section of the drive controller
- brake control via X6
- the control section of the drive controller with the optional modules, except for such optional modules (e.g. safety technology S1) which require their own power supply

Control Voltage Block Diagram The control voltage, which is supplied via the connection for 24V supply, takes effect according to the following block diagram.

Instructions for Use

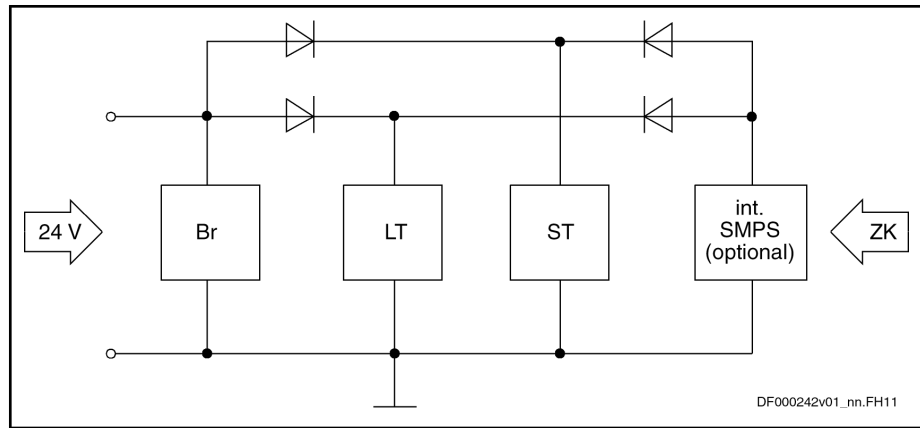

DF000242v01_nn.FH11

BR Circuit for brake control
 LT Power section, e.g. HCS02
 ST Control section, e.g. CSB01
 int. SMPS For types HCS0x.1E-Wxxx-NxxV: Internal switched-mode power supply

ZK DC bus

Fig.5-12: Block Diagram of Internal Control Voltage

Assignment	Conne- ction	Signal name	Function
 DG000115v01_nn.FH11	4	+24V	Power supply and "looping through"
	3	+24V	
	2	0V	Reference potential for power supply and "looping through"
	1	0V	
Spring terminal (connector)	Unit	Min.	Max.
Connection cross section solid wire	mm ²	1,0	1,5
Connection cross section stranded wire	mm ²	1,0	1,5
Connection cross section	AWG	18	16
Power consumption	W	P _{N3} (see technical data of the device)	
Voltage load capacity	V	U _{N3} (see technical data of the device)	
Current carrying capacity "looping through" from +24V to +24V, 0V to 0V Continuous current P _{N3} /U _{N3}	A		6
Current carrying capacity "looping through" from +24V to +24V, 0V to 0V Inrush current I _{Ein3}	A		12
Polarity reversal protection		Within the allowed voltage range by internal protective diode	

Fig.5-13: Function, Pin Assignment, Properties

Notes on Installation

Requirements on the connection to the 24V supply:

- Minimum cross section: 1 mm²

- Maximum allowed inductance: 100 μ H (2 twisted single strands, 75 m long)
- Parallel line routing where possible

The control voltage supply is routed to the connection X13 from **above**:



1 Lines to control voltage supply
 Fig.5-14: Control Voltage Supply at X13

The input 0V is connected in conductive form to the housing potential. It is therefore impossible to use an insulation monitor at +24V and 0V against housing.

5.2.8 L+ L-, DC Bus Connection

⚠ WARNING Lethal electric shock by live parts with more than 50 V!

Before working on live parts: De-energize installation and secure power switch against unintentional or unauthorized re-energization.

Wait at least **30 minutes** after switching off the supply voltages to allow **discharging**.

Check whether voltage has fallen below 50 V before touching live parts!

Function, Pin Assignment

The DC bus connection connects

- several drive controllers to one another
- a drive controller to additional components

HCS02.1E-W0012 drive controllers do not have a DC bus connection.

Instructions for Use

Technical Data of the Connection Point

View	Identifica- tion	Function	
<p>DA000176v01_nn.FH11</p>	L+	Connection points for connecting DC bus connections	
	L-		
Screw connection M6 thread at device (terminal block)	Unit	Min.	Max.
Tightening torque	Nm	5,5	6,5
Short circuit protection		Via fusing elements connected in the incoming circuit to the mains connection	
Overload protection		Via fusing elements connected in the incoming circuit to the mains connection	
Current carrying capacity "looping through" from L+ to L+, L- to L- (contact bars in scope of supply of accessory HAS01)			
With contact bars -072	A		220
Additionally with contact bars -042 and end piece	A		245

Fig.5-15: Function, Pin Assignment, Properties

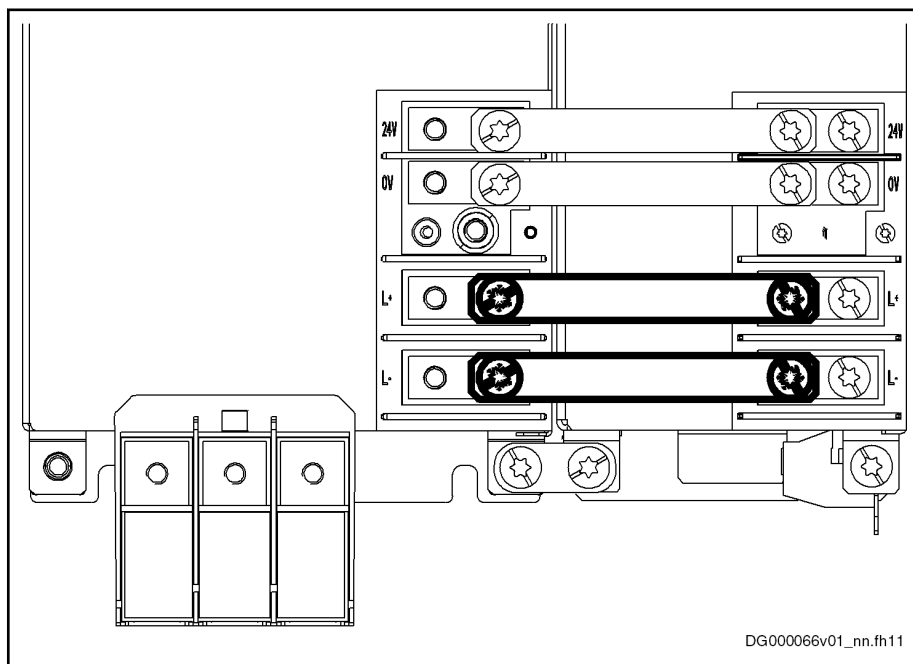

Fig.5-16: DC Bus Connection with Contact Bars

Notes on Installation If in special cases it is not possible to use the contact bars provided to establish the connection, the connection must be established using the shortest possible **twisted** wires.

NOTICE

Risk of damage by reversing the polarity of the DC bus connections L+ and L-

Make sure the polarity is correct.

Length of twisted wire	Max. 2 m
Line cross section	Min. 10 mm ² , but not smaller than cross section of supply feeder
Line protection	By means of fuses in the mains connection
Dielectric strength of single strand against ground	≥ 750 V (e.g.: strand type – H07)

Fig.5-17: DC Bus Line

5.2.9 Ground Connection

The ground connection of the housing is used to provide functional safety of the drive controllers and protection against contact in conjunction with the equipment grounding conductor.

Ground the housings of the drive controllers:

1. Connect the bare metal back panel of the drive controller in conductive form to the mounting surface in the control cabinet. To do this, use the supplied mounting screws.
2. Connect the mounting surface of the control cabinet in conductive form to the equipment grounding system.
3. For the ground connection, observe the maximum allowed ground resistance.

See Project Planning Manual of the drive system (index entry "Mains connection → Project planning").

5.2.10 Shield Connection

XS1, Shield Connection Control Lines

NOTICE

Property damage due to temperatures higher than 105 °C!

Observe the indicated minimum distances!

Above the devices there may only be such materials which

- are not combustible
- are insensitive to the occurring high temperatures



Always connect the shields with the largest possible metal-to-metal contact surface.

Instructions for Use

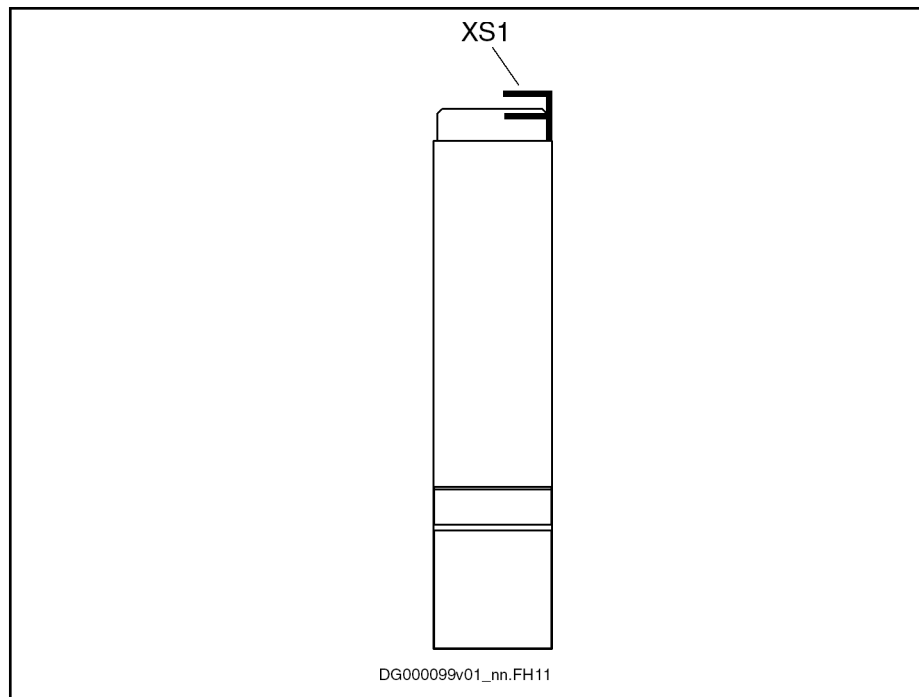

Fig.5-18: Shield Connection XS1 (Control Lines)

Function Connection point for the shields of lines connected to the control section and of which the connectors do not have their own shield connection.

XS2, Shield Connection Motor Cable

NOTICE

Risk of damage to the drive controller by too long screws!

Exclusively use screws of a **maximum length of 12 mm** for the thread of shield connection XS2.

The connection consists of an M6 thread and is used for mounting the fixing device for shield connection of the motor cable.

The **accessory HAS02** contains all parts required for effective shield connection of the motor cable (see index entry "Accessories").

5.3 Installation

5.3.1 General Information on How to Install the Drive Controller

⚠ WARNING

Lethal electric shock by live parts with more than 50 V!

Before working on live parts: De-energize installation and secure power switch against unintentional or unauthorized re-energization.

Wait at least **30 minutes** after switching off the supply voltages to allow **discharging**.

Check whether voltage has fallen below 50 V before touching live parts!

Damage can be caused to the drive controller or circuit boards if electrostatic charging present in people and/or tools is discharged across them. For this reason, please observe the following information:

NOTICE

Electrostatic charges can cause damage to electronic components and interfere with their operational safety!

Exposed conductive parts coming into contact with components and circuit boards must be discharged by means of grounding. Otherwise errors may occur when controlling motors and moving elements.

Such exposed conductive parts include:

- The copper bit when soldering
- The human body (ground connection by touching a conductive, grounded object)
- Parts and tools (place them on a conductive support)

Endangered components may only be stored or dispatched in conductive packaging.



Rexroth connection diagrams are only to be used for producing installation circuit diagrams! The machine manufacturer's installation circuit diagrams must be used for wiring the installation!

- Lay signal lines separately from the load resistance lines because of the occurrence of interference.
- Transmit analog signals (e.g. command values, actual values) via shielded lines.
- Do not connect mains, DC bus or power cores to low voltages or allow them to come into contact with these.
- When carrying out a high voltage test or an applied-overvoltage withstand test on the machine's electrical equipment, disconnect all connections to the devices. This protects the electronic components (allowed in accordance with EN 60204-1). During their routine testing, Rexroth drive components are tested for high voltage (in accordance with EN 61800-5-1:2007, section 5.2.3.2) and insulation (in accordance with EN 60204-1:2006, section 18.3).

NOTICE

Risk of damage to the drive controller by connecting and disconnecting live connections!

Do not connect and disconnect live connections.

Instructions for Use

5.3.2 Sizing of Enclosure and Control Cabinet

Multiple-Line Design of the Control Cabinet



Arrangement of the devices, air guides/drip protections, fans

Pay particular attention to the maximum allowed air intake temperature of devices when they are arranged in multiple lines in the control cabinet.

If possible, place devices with a high degree of power dissipation (e.g. supply units with braking resistors, DC bus resistor units)

- in the top line and
- near the outlet air aperture to the cooling unit

Mount **air guides** between the lines to

- protect the devices in the upper lines against the warm outlet air of the devices beneath and
- protect the devices beneath against penetration of liquids (e.g. dripping condensation water or leaking cooling liquid)

Additional fans convey the outlet air to the cooling unit and cooling air to the upper lines.

At the installed control cabinet, check the air intake temperature of all devices.



To extend the module bus connection, the accessory RKB0001 is available. Observe the assignment.

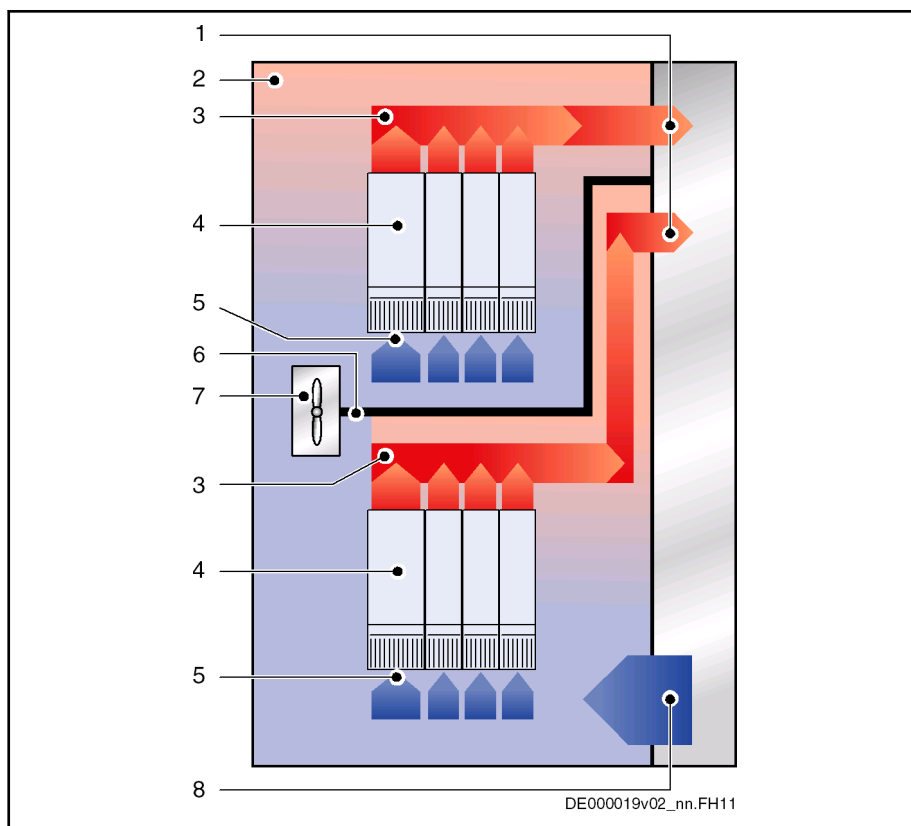

- 1 Discharge of heated air to cooling unit
- 2 Interior of control cabinet
- 3 Conveying direction of heated air in area where air flows off
- 4 Device in control cabinet
- 5 Air intake at device
- 6 Air guide in control cabinet (for liquid cooling, this is also the drip protection for the devices beneath)
- 7 Fan in control cabinet
- 8 Supply of cooled air from cooling unit

Fig.5-19: Example of Arrangement for Double-Line Design

Arranging the Cooling Units

Unless the nominal data are reduced, the drive controller may only be operated up to a specified maximum ambient temperature. A cooling unit might therefore be required.

NOTICE Possible damage to the drive controller! Operational safety of the machine endangered!

Observe the instructions below.

Avoiding Dripping or Spraying Water

Due to their operating principle, condensation water is formed when cooling units are used.

For this reason, observe the following aspects:

- Always position cooling units in such a way that condensation water cannot drip onto the devices in the control cabinet.

Instructions for Use

- Position the cooling unit in such a way that the fan of the cooling unit does not spray accumulated condensation water onto the devices in the control cabinet. Mount the air duct in the control cabinet accordingly.

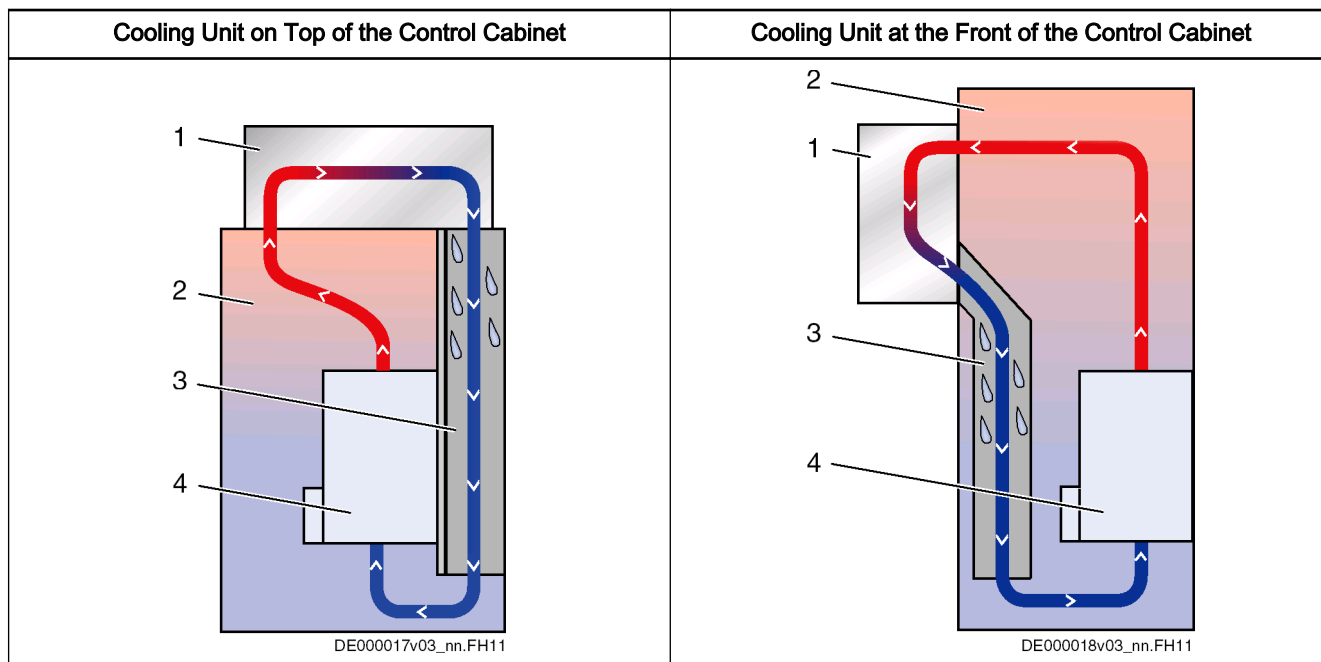

- | | |
|---|--|
| 1 | Cooling unit |
| 2 | Interior of control cabinet |
| 3 | Air duct (protects devices against condensation water) |
| 4 | Device in control cabinet |

Fig.5-20: Arranging the Cooling Units

Avoiding Moisture Condensation

Moisture condensation occurs when the temperature of the device is lower than the ambient temperature.

- Set cooling units with temperature adjustment to the maximum surrounding temperature and not lower!
- Set cooling units with follow-up temperature in such a way that the interior temperature of the control cabinet is not lower than the temperature of the surrounding air. Set the temperature limitation to the maximum surrounding temperature!
- Only use well-sealed control cabinets so that moisture condensation cannot arise as a result of warm and moist external air entering the cabinet.
- In the event that control cabinets are operated with the doors open (commissioning, servicing etc.), it is essential to ensure that after the doors are closed the drive controllers cannot at any time be cooler than the air in the control cabinet. For this reason, sufficient circulation must be provided inside the control cabinet.

6 EMC Measures for Design and Installation

6.1 Rules for Design of Installations With Drive Controllers in Compliance With EMC

The following rules are the basics for designing and installing drives in compliance with EMC.

Mains filter	Correctly use a mains filter recommended by Rexroth for radio interference suppression in the supply feeder of the drive system.
Control Cabinet Grounding	Connect all metal parts of the cabinet with one another over the largest possible surface area to establish a good electrical connection. This, too, applies to the mounting of the mains filter. If required, use serrated washers which cut through the paint surface. Connect the cabinet door to the control cabinet using the shortest possible grounding straps.
Line Routing	<p>Avoid coupling routes between lines with high potential of noise and noise-free lines; therefore, signal, mains and motor lines and power cables have to be routed separately from another. Minimum distance: 10 cm. Provide separating sheets between power and signal lines. Ground separating sheets several times.</p> <p>The lines with high potential of noise include:</p> <ul style="list-style-type: none">• Lines at the mains connection (incl. synchronization connection)• Lines at the motor connection• Lines at the DC bus connection <p>Generally, interference injections are reduced by routing cables close to grounded sheet steel plates. For this reason, cables and wires should not be routed freely in the cabinet, but close to the cabinet housing or mounting panels. Separate the incoming and outgoing cables of the radio interference suppression filter.</p>
Interference Suppression Elements	<p>Provide the following components in the control cabinet with interference suppression combinations:</p> <ul style="list-style-type: none">• Contactors• Relays• Solenoid valves• Electromechanical operating hours counters <p>Connect these combinations directly at each coil.</p>
Twisted Wires	Twist unshielded wires belonging to the same circuit (feeder and return cable) or keep the surface between feeder and return cable as small as possible. Wires that are not used have to be grounded at both ends.
Lines of Measuring Systems	Lines of measuring systems must be shielded. Connect the shield to ground at both ends and over the largest possible surface area. The shield may not be interrupted, e.g. using intermediate terminals.
Digital Signal Lines	Ground the shields of digital signal lines at both ends (transmitter and receiver) over the largest possible surface area and with low impedance. In the case of bad ground connection between transmitter and receiver, additionally route a bonding conductor (min. 10 mm ²). Braided shields are better than foil shields.
Analog Signal Lines	Ground the shields of analog signal lines at one end (transmitter or receiver) over the largest possible surface area and with low impedance. This avoids low-frequency interference current (in the mains frequency range) on the shield.

EMC Measures for Design and Installation

Connecting the Mains Choke Keep connection lines of the mains choke at the drive controller as short as possible and twist them.

- Installing the Motor Power Cable**
- Use shielded motor power cables or run motor power cables in a shielded duct
 - Use the shortest possible motor power cables
 - Ground shield of motor power cable at both ends over the largest possible surface area to establish a good electrical connection
 - Run motor lines in shielded form inside the control cabinet
 - Do not use any steel-shielded lines
 - The shield of the motor power cable mustn't be interrupted by mounted components, such as output chokes, sine filters or motor filters

6.2 EMC-Optimal Installation in Facility and Control Cabinet

6.2.1 General Information

For EMC-optimal installation, a spatial separation of the interference-free area (mains connection) and the interference-susceptible area (drive components) is recommended, as shown in the figures below.



Recommendation: For EMC-optimal installation in the control cabinet, use a separate control cabinet panel for the drive components.

6.2.2 Division Into Areas (Zones)

Exemplary arrangements in the control cabinet: See section [Control Cabinet Design According to Interference Areas - Exemplary Arrangements, page 52](#).

We distinguish three areas:

1. Interference-free area of control cabinet (**area A**):

This includes:

- Supply feeder, input terminals, fuse, main switch, mains side of mains filter for drives and corresponding connecting lines
- Control voltage or auxiliary voltage connection with power supply unit, fuse and other parts unless connection is run via the mains filter of the AC drives
- All components that are not electrically connected with the drive system

2. Interference-susceptible area (**area B**):

- Mains connections between drive system and mains filter for drives, mains contactor
- Interface lines of drive controller

3. Strongly interference-susceptible area (**area C**):

- Motor power cables including single cores

Never run lines of one of these areas in parallel with lines of another area so that there isn't any unwanted interference injection from one area to the other and that the filter is jumpered with regard to high frequency. Use the shortest possible connecting lines.

EMC Measures for Design and Installation

Recommendation for complex systems: Install drive components in one cabinet and the control units in a second, separate cabinet.

Badly grounded control cabinet doors act as antennas. Therefore, connect the control cabinet doors to the cabinet on top, in the middle and on the bottom via short equipment grounding conductors with a cross section of at least 6 mm² or, even better, via grounding straps with the same cross section. Make sure connection points have good contact.

EMC Measures for Design and Installation

6.2.3 Control Cabinet Design According to Interference Areas - Exemplary Arrangements

Infeding Supply Unit or Converter

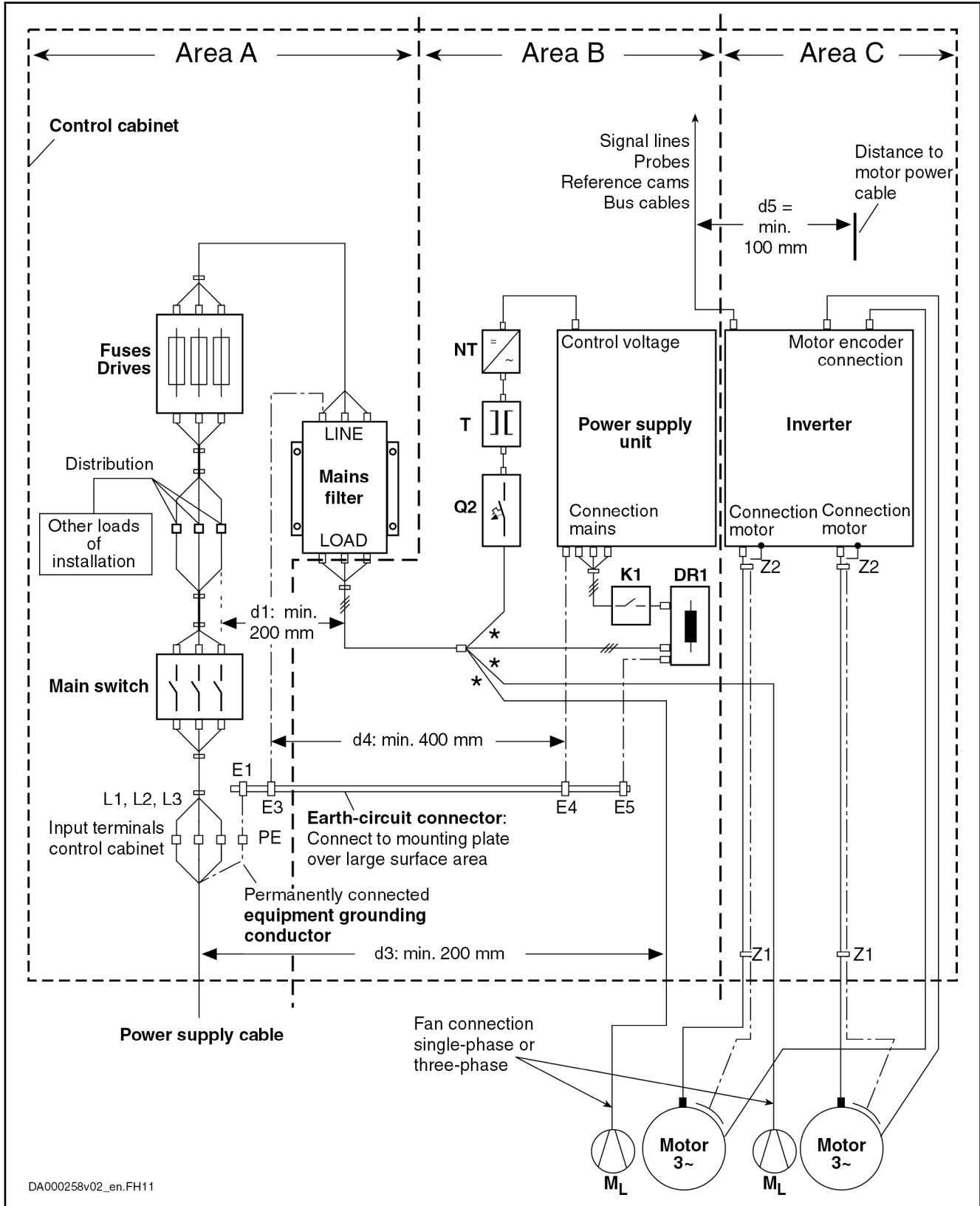

DA000258v02_en.FH11

DR1

Mains choke (optional)

EMC Measures for Design and Installation

E1...E5	Equipment grounding conductor of the components
K1	External mains contactor for supply units and converters without integrated mains contactor
M _L	Motor fan
NT	Power supply unit
Q2	Fusing
T	Transformer
Z1, Z2	Shield connection points for cables
*	Not allowed at HNF mains filter

Fig. 6-1: *Infeeding Supply Unit or Converter – EMC Areas in the Control Cabinet*

6.2.4 Design and Installation in Area A - Interference-Free Area of Control Cabinet

Arranging the Components in the Control Cabinet

Comply with recommended distance of at least **200 mm** (distance d1 in the figure):

- Between components and electrical elements (switches, pushbuttons, fuses, terminal connectors) in the interference-free area A and the components in the two other areas B and C

Comply with recommended distance of at least **400 mm** (distance d4 in the figure):

- Between magnetic components (such as transformers, mains chokes and DC bus chokes that are directly connected to the power connections of the drive system) and the interference-free components and lines between mains and filter including the mains filter in area A

If these distances are not kept, the magnetic leakage fields are injected to the interference-free components and lines connected to the mains and the limit values at the mains connection are exceeded in spite of the installed filter.

Cable Routing of the Interference-Free Lines to the Mains Connection

Comply with recommended distance of at least **200 mm** (distance d1 and d3 in the figure):

- Between supply feeder or lines between filter and exit point from the control cabinet in area A and the lines in area B and C

If this is impossible, there are two alternatives:

1. Install lines in shielded form and connect the shield at several points (at least at the beginning and at the end of the line) to the mounting plate or the control cabinet housing over a large surface area.
2. Separate lines from the other interference-susceptible lines in areas B and C by means of a grounded distance plate vertically attached to the mounting plate.

Install the shortest possible lines within the control cabinet and install them directly on the grounded metal surface of the mounting plate or of the control cabinet housing.

Mains supply lines from areas B and C must not be connected to the mains without a filter.



In case you do not observe the information on cable routing given in this section, the effect of the mains filter is totally or partly neutralized. This will cause the noise level of the interference emission to be higher within the range of 150 kHz to 40 MHz and the limit values at the connection points of the machine or installation will thereby be exceeded. Consider the specified distances to be recommended data, provided that the dimensions of the control cabinet allow installing the lines accordingly.

EMC Measures for Design and Installation

Routing and Connecting a Neutral Conductor (N)	<p>If a neutral conductor is used together with a three-phase connection, it must not be installed unfiltered in zones B and C, in order to keep interference off the mains.</p>
Motor Fan at Mains Filter	<p>Single-phase or three-phase supply lines of motor fans, that are usually routed in parallel with motor power cables or interference-susceptible lines, must be filtered:</p> <ul style="list-style-type: none"> • In drive systems with regenerative supply units, via a separate single-phase (NFE type) or three-phase filter (HNF type) near the mains connection of the control cabinet • In drive systems with only infeeding supply units, via the available three-phase filter of the drive system <p>When switching power off, make sure the fan is not switched off. When switching power off, make sure the fan is not switched off.</p>
Loads at Mains Filter of Drive System	<hr/> <p> Only operate allowed loads at the mains filter of the drive system!</p> <p>At the three-phase filter for the power connection of regenerative supply units, it is only allowed to operate the following loads:</p> <ul style="list-style-type: none"> • HMV supply unit with mains choke and, if necessary, mains contactor <p>Do not operate any motor fans, power supply units etc. at the mains filter of the drive system.</p> <hr/>
Shielding Mains Supply Lines in Control Cabinet	<p>If there is a high degree of interference injection to the mains supply line within the control cabinet, although you have observed the above instructions (to be found out by EMC measurement according to standard), proceed as follows:</p> <ul style="list-style-type: none"> • Only use shielded lines in area A • Connect shields to the mounting plate at the beginning and the end of the line by means of clips <p>The same procedure may be required for long cables of more than 2 m between the point of power supply connection of the control cabinet and the filter within the control cabinet.</p>
Mains Filters for AC Drives	<p>Ideally mount the mains filter on the parting line between the areas A and B. Make sure the ground connection between filter housing and housing of the drive controllers has good electrically conductive properties.</p> <p>If single-phase loads are connected on the load side of the filter, their current may be a maximum of 10% of the three-phase operating current. A highly imbalanced load of the filter would deteriorate its interference suppression capacity.</p> <p>If the mains voltage is more than 480 V, connect the filter to the output side of the transformer and not to the supply side of the transformer.</p>
Grounding	<p>In the case of bad ground connections in the installation, the distance between the lines to the grounding points E1, E2 in area A and the other grounding points of the drive system should be at least $d_4 = 400$ mm, in order to minimize interference injection from ground and ground cables to the power input lines.</p> <p>See also 6.2.2 Division Into Areas (Zones), page 50.</p>
Point of Connection for Equipment Grounding Conductor at Machine, Installation, Control Cabinet	<p>The equipment grounding conductor of the power cable of the machine, installation or control cabinet has to be permanently connected at point PE and have a cross section of at least 10 mm² or to be complemented by a second equipment grounding conductor via separate terminal connectors (according to EN 61800-5-1:2007, section 4.3.5.5.2). If the cross section of the outer</p>

conductor is bigger, the cross section of the equipment grounding conductor must be accordingly bigger.

6.2.5 Design and Installation in Area B - Interference-Susceptible Area of Control Cabinet

Arranging Components and Lines	<p>Modules, components and lines in area B should be placed at a distance of at least d1 = 200 mm from modules and lines in area A.</p> <p>Alternative: Shield modules, components and lines in area B by distance plates mounted vertically on the mounting plate from modules and lines in area A or use shielded lines.</p> <p>Only connect power supply units for auxiliary or control voltage connections in the drive system to the mains via a mains filter. See 6.2.2 Division Into Areas (Zones), page 50.</p> <p>Install the shortest possible lines between drive controller and filter.</p>
Control Voltage or Auxiliary Voltage Connection	<p>Only in exceptional cases should you connect power supply unit and fusing for the control voltage connection to phase and neutral conductor. In this case, mount and install these components in area A far away from the areas B and C of the drive system. For details see section 6.2.4 Design and Installation in Area A - Interference-Free Area of Control Cabinet, page 53.</p> <p>Run the connection between control voltage connection of the drive system and power supply unit used through area B over the shortest distance.</p>
Line Routing	<p>Run the lines along grounded metal surfaces, in order to minimize radiation of interference fields to area A (transmitting antenna effect).</p>

6.2.6 Design and Installation in Area C - Strongly Interference-Susceptible Area of Control Cabinet

	<p>Area C mainly concerns the motor power cables, especially at the connection point at the drive controller.</p>
Influence of the Motor Power Cable	<p>The longer the motor power cable, the greater its leakage capacitance. To comply with a certain EMC limit value, the allowed leakage capacitance of the mains filter is limited. For the calculation of the leakage capacitance, see the documentation on the drive system of the drive controller used.</p>
	<hr/>  <ul style="list-style-type: none">• Run the shortest possible motor power cables.• Only use shielded motor power cables by Rexroth. <hr/>
Routing the Motor Power Cables and Motor Encoder Cables	<p>Route the motor power cables and motor encoder cables along grounded metal surfaces, both inside the control cabinet and outside of it, in order to minimize radiation of interference fields. If possible, route the motor power cables and motor encoder cables in metal-grounded cable ducts.</p> <p>Route the motor power cables and motor encoder cables</p> <ul style="list-style-type: none">• with a distance of at least d5 = 100 mm to interference-free lines, as well as to signal cables and signal lines (alternatively separated by a grounded distance plate)• in separate cable ducts, if possible
Routing the Motor Power Cables and Mains Connection Lines	<p>For converters (drive controllers with individual mains connection), route motor power cables and (unfiltered) mains connection lines in parallel for a maximum distance of 300 mm. After that distance, route motor power cables and power supply cables in opposite directions and preferably in separate cable ducts.</p>

EMC Measures for Design and Installation

Ideally, the outlet of the motor power cables at the control cabinet should be provided in a distance of at least $d_3 = 200 \text{ mm}$ from the (filtered) power supply cable.

Converter - Routing the Motor Power Cables

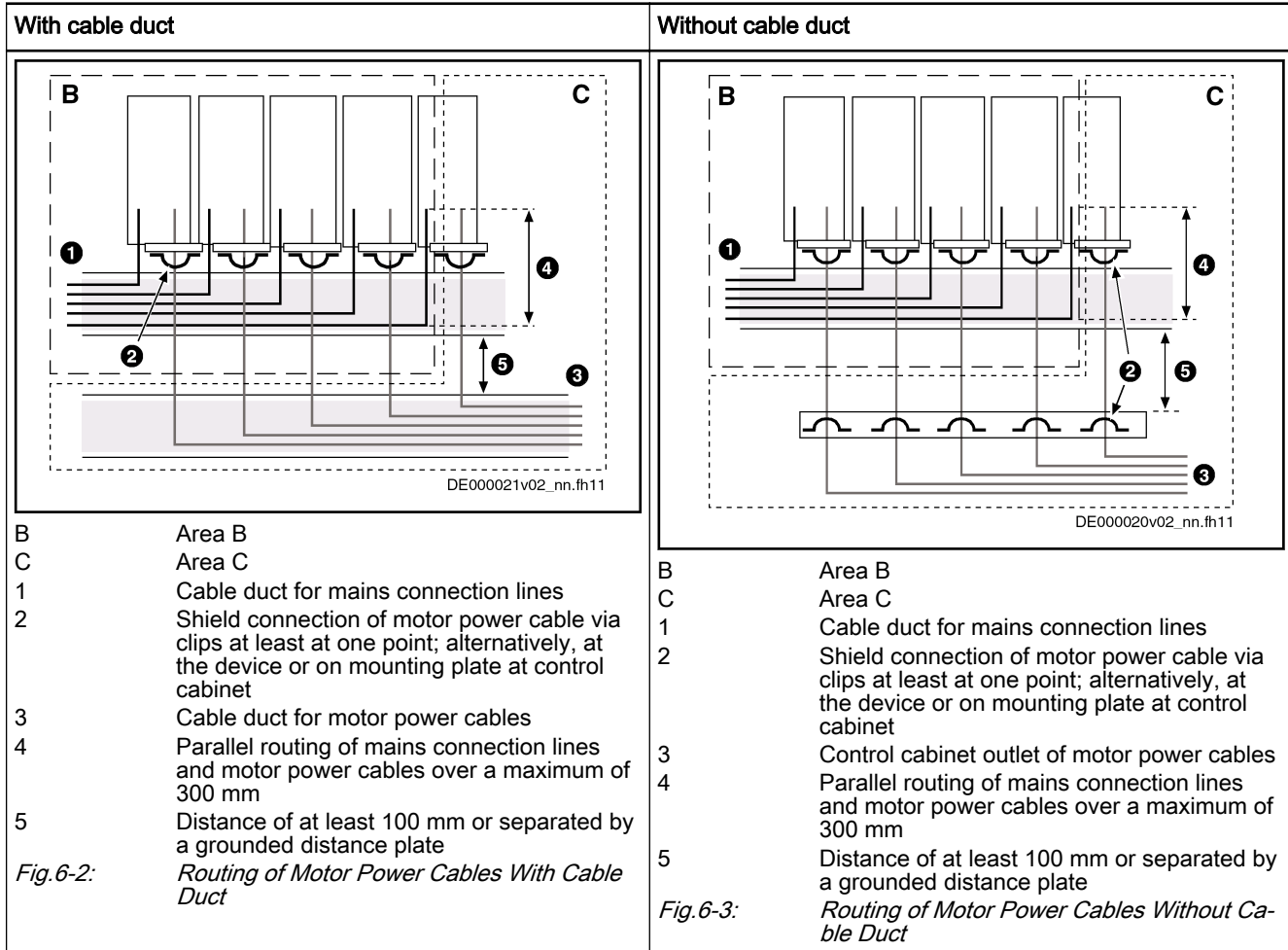

Fig. 6-4: Routing of Cables for Converter

6.3 Ground Connections

Housing and Mounting Plate

By means of appropriate ground connections, it is possible to avoid the emission of interference, because interference is discharged to ground on the shortest possible way.

Ground connections of the metal housings of EMC-critical components (such as filters, devices of the drive system, connection points of the cable shields, devices with microprocessor and switching power supply units) have to be well contacted over a large surface area. This also applies to all screw connections between mounting plate and control cabinet wall and to the mounting of a ground bus to the mounting plate.

The best solution is to use a zinc-coated mounting plate. Compared to a lacquered plate, the connections in this case have a good long-time stability.

Connection Elements

For lacquered mounting plates, always use screw connections with tooth lock washers and zinc-coated, tinned screws as connection elements. At the connection points, remove the lacquer so that there is safe electrical contact over a large surface area. You achieve contact over a large surface area by

EMC Measures for Design and Installation

means of bare connection surfaces or several connection screws. For screw connections, you can establish the contact to lacquered surfaces by using tooth lock washers.

Metal Surfaces Always use connection elements (screws, nuts, plain washers) with good electroconductive surface.

Bare zinc-coated or tinned metal surfaces have **good electroconductive properties**.

Anodized, yellow chromated, black gunmetal finish or lacquered metal surfaces have **bad electroconductive properties**.

Ground Wires and Shield Connections

For connecting ground wires and shield connections, it is not the cross section but the size of contact surface that is important, as the high-frequency interference currents mainly flow on the surface of the conductor.

Always connect cable shields, especially shields of the motor power cables, to ground potential over a large surface area.

6.4 Installing Signal Lines and Signal Cables

Line Routing For measures to prevent interference, see the Project Planning Manuals of the respective device. In addition, we recommend the following measures:

- Route signal and control lines separately from the power cables with a minimum distance of **d5 = 100 mm** (see [6.2.2 Division Into Areas \(Zones\), page 50](#)) or with a grounded separating sheet. The optimum way is to route them in separate cable ducts. If possible, lead signal lines into the control cabinet at one point only.
- If signal lines are crossing power cables, route them in an angle of 90° in order to avoid interference injection.
- Ground spare cables, that are not used and have been connected, at least at both ends so that they do not have any antenna effect.
- Avoid unnecessary line lengths.
- Run cables as close as possible to grounded metal surfaces (reference potential). The ideal solution are closed, grounded cable ducts or metal pipes which, however, is only obligatory for high requirements (sensitive instrument leads).
- Avoid suspended lines or lines routed along synthetic carriers, because they are functioning like reception antennas (noise immunity) and like transmitting antennas (emission of interference). Exceptional cases are flexible cable tracks over short distances of a maximum of 5 m.

Shielding Connect the cable shield immediately at the devices in the shortest and most direct possible way and over the largest possible surface area.

Connect the shield of **analog signal lines** at one end over a large surface area, normally in the control cabinet at the analog device. Make sure the connection to ground/housing is short and over a large surface area.

Connect the shield of **digital signal lines** at both ends over a large surface area and in short form. In the case of potential differences between beginning and end of the line, run an additional bonding conductor in parallel. This prevents compensating current from flowing via the shield. The guide value for the cross section is 10 mm².

You absolutely have to equip separable connections with connectors with grounded metal housing.

In the case of non-shielded lines belonging to the same circuit, twist feeder and return cable.

EMC Measures for Design and Installation

6.5 General Measures of Radio Interference Suppression for Relays, Contactors, Switches, Chokes and Inductive Loads

If, in conjunction with electronic devices and components, inductive loads, such as chokes, contactors, relays are switched by contacts or semiconductors, appropriate interference suppression has to be provided for them:

- By arranging free-wheeling diodes in the case of d.c. operation
- In the case of a.c. operation, by arranging usual RC interference suppression elements depending on the contactor type, immediately at the inductance

Only the interference suppression element arranged immediately at the inductance does serve this purpose. Otherwise, the emitted noise level is too high which can affect the function of the electronic system and of the drive.

7 Accessories

7.1 Overview

Overview	Content and usage
 <p>DG000330v01_nn.fh11</p>	<p>Accessory HAS01 contains:</p> <p>a) Screws to fix the device in the control cabinet</p> <p>b) Adhesive labels with notes on safety in the English and French languages. Place the adhesive labels clearly visibly at the device or in the immediate vicinity of the device, if the adhesive labels existing at the device are hidden by neighboring devices.</p> <p>c) Contact bars for connecting</p> <ul style="list-style-type: none"> the DC bus the control voltage supply For high-performance devices, there are additional elements which increase the current carrying capacity of the DC bus connections and which are screwed to the contact bars:  <p>d) Joint bar to connect the equipment grounding connections of neighboring devices</p> <p>The accessory HAS02 is screwed to the bottom of the device and used to</p> <ul style="list-style-type: none"> connect the motor cable shield to the device provide strain relief of the motor cable <p>The accessory HAS03 (control cabinet adapter) is used to compensate different mounting depths of devices mounted to a common mounting surface.</p> <ul style="list-style-type: none"> Maximum allowed tightening torque: 6 Nm Mechanical stability of a device with HAS03 requires the rigid connection via DC bus contact bars to a neighboring device without HAS03.

Fig.7-1: Accessories – Overview

7.2 Information on Accessory HAS02

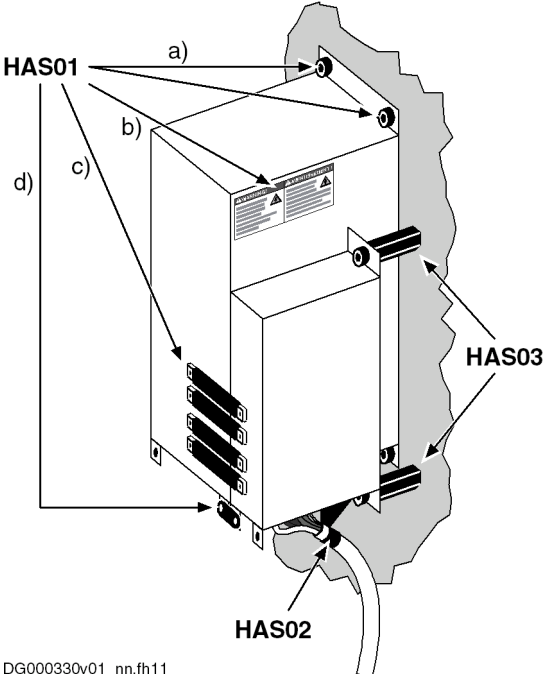
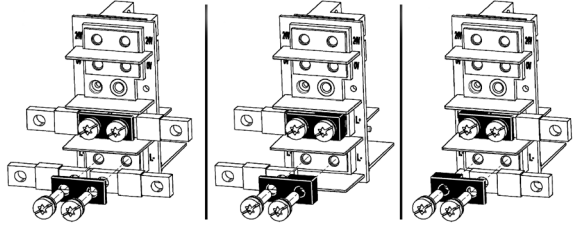
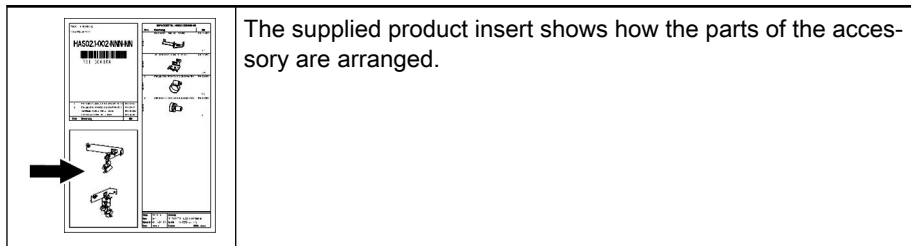
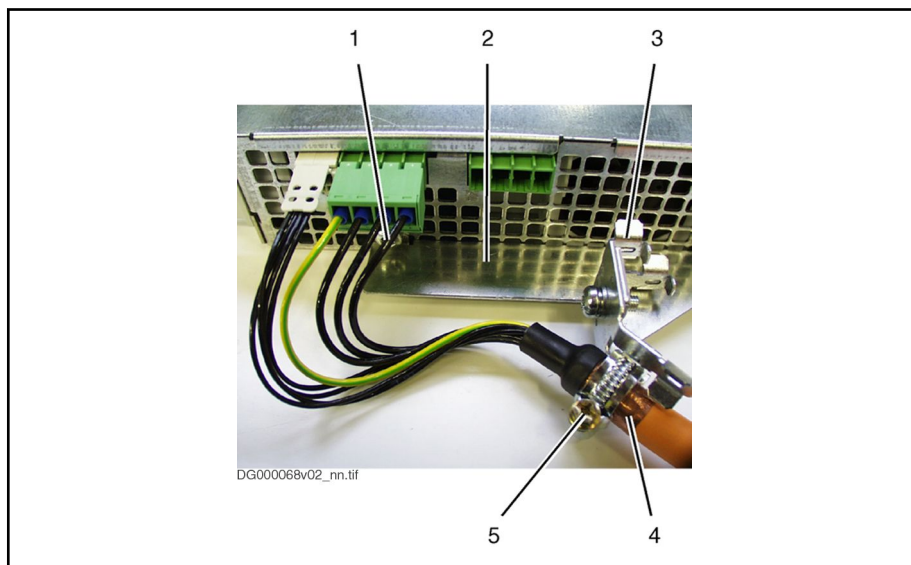

Fig.7-2: Product Insert

Mounting Example Accessory HAS02.1-002



- | | |
|---|-------------------------------------|
| 1 | Screw in thread at bottom of device |
| 2 | Fixing device |
| 3 | Shielding plate |
| 4 | Shield of motor cable |
| 5 | Clip |

Fig.7-3: Strain Relief and Shield Connection of Motor Cable

How to mount the accessory

1. Unscrew bottom mounting screw of device.
2. Put fixing device to bottom of device and screw down mounting screw of device again.
3. Screw supplied screw in thread at bottom of device.
4. Screw shielding plate to fixing device according to desired cable routing of motor cable. (The figure illustrates cable routing with 45°.)
5. According to diameter of motor cable, fix motor cable at corresponding point of shielding plate with a clip. Make sure that shield of motor cable has good contact with shielding plate.

The mounting of the accessory is similar for all devices. Exception: With HAS02.1-010 (at HMS02.1N-W0028 / 54), the fixing device is screwed to the equipment grounding conductor connections of the device.

8 Service and Support

Our worldwide service network provides an optimized and efficient support. Our experts offer you advice and assistance should you have any queries. You can contact us **24/7**.

Service Germany Our technology-oriented Competence Center in Lohr, Germany, is responsible for all your service-related queries for electric drive and controls.

Contact the **Service Helpdesk & Hotline** under:

Phone:	+49 9352 40 5060
Fax:	+49 9352 18 4941
E-mail:	service.svc@boschrexroth.de
Internet:	http://www.boschrexroth.com

Additional information on service, repair (e.g. delivery addresses) and training can be found on our internet sites.

Service worldwide Outside Germany, please contact your local service office first. For hotline numbers, refer to the sales office addresses on the internet.

Preparing information To be able to help you more quickly and efficiently, please have the following information ready:

- Detailed description of malfunction and circumstances resulting in the malfunction
- Type plate name of the affected products, in particular type codes and serial numbers
- Your contact data (phone and fax number as well as your email address)

9 Environmental Protection and Disposal

9.1 Environmental Protection

Production Processes	The products are made with energy- and resource-optimized production processes which allow re-using and recycling the resulting waste. We regularly try to replace pollutant-loaded raw materials and supplies by more environment-friendly alternatives.														
No Release of Hazardous Substances	Our products do not contain any hazardous substances which may be released in the case of appropriate use. Normally, our products will not have any negativ influences on the environment.														
Significant Components	Basically, our products contain the following components: <table><tr><td>Electronic devices</td><td>Motors</td></tr><tr><td>• steel</td><td>• steel</td></tr><tr><td>• aluminum</td><td>• aluminum</td></tr><tr><td>• copper</td><td>• copper</td></tr><tr><td>• synthetic materials</td><td>• brass</td></tr><tr><td>• electronic components and modules</td><td>• magnetic materials</td></tr><tr><td></td><td>• electronic components and modules</td></tr></table>	Electronic devices	Motors	• steel	• steel	• aluminum	• aluminum	• copper	• copper	• synthetic materials	• brass	• electronic components and modules	• magnetic materials		• electronic components and modules
Electronic devices	Motors														
• steel	• steel														
• aluminum	• aluminum														
• copper	• copper														
• synthetic materials	• brass														
• electronic components and modules	• magnetic materials														
	• electronic components and modules														

9.2 Disposal

Return of Products	<p>Our products can be returned to our premises free of charge for disposal. It is a precondition, however, that the products are free of oil, grease or other dirt. Furthermore, the products returned for disposal must not contain any undue foreign material or foreign components.</p> <p>Send the products "free domicile" to the following address:</p> <p style="text-align: center;">Bosch Rexroth AG Electric Drives and Controls Buergermeister-Dr.-Nebel-Strasse 2 97816 Lohr am Main, Germany</p>
Packaging	<p>The packaging materials consist of cardboard, wood and polystyrene. These materials can be recycled anywhere without any problem.</p> <p>For ecological reasons, please refrain from returning the empty packages to us.</p>
Batteries and Accumulators	<p>Batteries and accumulators can be labeled with this symbol.</p> <p></p> <p>The symbol indicating "separate collection" for all batteries and accumulators is the crossed-out wheeled bin.</p> <p>The end user within the EU is legally obligated to return used batteries. Outside the validity of the EU Directive 2006/66/EC keep the stipulated directives.</p> <p>Used batteries can contain hazardous substances, which can harm the environment or the people's health when they are improper stored or disposed of. After use, the batteries or accumulators contained in Rexroth products have to be properly disposed of according to the country-specific collection.</p>
Recycling	<p>Most of the products can be recycled due to their high content of metal. In order to recycle the metal in the best possible way, the products must be disassembled into individual modules.</p>

Environmental Protection and Disposal

Metals contained in electric and electronic modules can also be recycled by means of special separation processes.

Products made of plastics can contain flame retardants. These plastic parts are labeled according to EN ISO 1043. They have to be recycled separately or disposed of according to the valid legal requirements.

Index

Symbols

24V supply.....	39
Internal	39

A

Accessories	
HAS01, HAS02, HAS03	59
Accumulators.....	63
Additional documentations.....	25

B

Batteries.....	63
Braking resistor	
External	37

C

Cables	
Documentation	26
Components	
Documentations	25
Connection	
Braking resistor	37
Control voltage	39
DC bus	41
Equipment grounding conductor	31
Ground	43
Mains	31
Motor	33
Motor holding brake	34
Motor temperature monitoring	34
Shield (control lines)	43
Shield (motor cable)	44
Connection diagram.....	30
Connection points.....	29
Contained substances	
see "Significant components"	63
Control cabinet	
Area A, interference-free	53
Area B, interference-susceptible	55
Area C, strongly interference-susceptible	55
Avoiding moisture condensation	48
Cooling unit	47
Interference areas	52
Multiple-line arrangement of drive con- trollers	46
Control voltage.....	39
Supply	39
Cooling unit	
Arrangement	47

D

DC bus	
Connection	41

D

Dimensions.....	23
Disposal.....	63
Distances.....	24
Documentation	
Cables	26
Drive systems	25
Firmware	26
Motors	25
Overview	25
Reference documentations	25
System components	25
Drive controllers	
Multiple-line arrangement	46

E

EMC	
Measures for design and installation	49
Environmental protection.....	63
Equipment grounding conductor	
Connection	31

F

Firmware	
Documentation	26

G

Ground	
Connection	43
Ground connection.....	43
Ground connections.....	56

H

HAS01, HAS02, HAS03	
Accessories	59
Hazardous substances.....	63
HCS02	
Scope of supply	22
Type code	21

I

Identification.....	21
Installation.....	44
EMC measures	49
General information	44
Ground connections	56
Signal lines	57
Instructions for use.....	29

L

L+, L-	
DC bus	41

Index

M

Mains connection.....	31
Mains filter	
Motor fan	54
Other loads	54
Measures of radio interference suppression	
For relays, contactors, switches, chokes, inductive loads	58
Moisture condensation	
Avoiding	48
Motor	
Documentation	25
Motor connection.....	33
Motor temperature monitoring and motor holding brake	34
Motor fan	
Mains filter	54
Multiple-line arrangement of drive controllers.....	46

O

Overcurrent protection.....	29
-----------------------------	----

P

Packaging.....	63
Power consumption.....	23
Production processes.....	63
Project planning manuals.....	25

R

Ratings.....	23
Recycling.....	63
Reference documentations.....	25
Return of products.....	63

S

Safety instructions.....	13
Scope of supply	
HCS02	22

S

Shield	
Connection (control lines)	43
Connection (motor cable)	44
Signal lines	
Installation	57
Significant components.....	63
Support	
See service hotline	61

T

Technical data.....	23
Type code	
HCS02	21
Type plates.....	22

U

Use	
Instructions	29

V

Voltage load capacity.....	23
----------------------------	----

W

Wiring diagram.....	29
---------------------	----

X

X13.....	39
X3.....	31
X5.....	33
X6.....	34
X9.....	37
XS1.....	43
XS2.....	44

Notes

Bosch Rexroth AG
Electric Drives and Controls
P.O. Box 13 57
97803 Lohr, Germany
Bgm.-Dr.-Nebel-Str. 2
97816 Lohr, Germany
Tel. +49 9352 18 0
Fax +49 9352 18 8400
www.boschrexroth.com/electrics

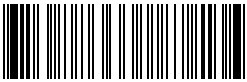

R911339018

DOK-INDRV*-HCS02*****-IT01-EN-P